

***Pioneer***

**AUDIO/VIDEO  
MULTI-CHANNEL RECEIVER**

**VSX-D859TX  
VSX-D859TXG**

**Operating Instructions**

Thank you for buying this Pioneer product. Please read through these operating instructions so you will know how to operate your model properly. After you have finished reading the instructions, put them away in a safe place for future reference.

If the socket outlets on the associated equipment are not suitable for the plug supplied with the product the plug must be removed and appropriate one fitted.

The cut-off plug must be disposed of as an electrical shock hazard could exist if connected to a socket outlet.

**WARNING:** TO PREVENT FIRE OR SHOCK HAZARD, DO NOT EXPOSE THIS APPLIANCE TO RAIN OR MOISTURE.

THE OFF/ON BUTTON IS SECONDARY CONNECTED AND THEREFORE DOES NOT SEPARATE THE UNIT FROM MAINS POWER IN STANDBY POSITION.

## IMPORTANT



The lightning flash with arrowhead symbol, within an equilateral triangle, is intended to alert the user to the presence of uninsulated "dangerous voltage" within the product's enclosure that may be of sufficient magnitude to constitute a risk of electric shock to persons.

### CAUTION

**RISK OF ELECTRIC SHOCK  
DO NOT OPEN**



**CAUTION:**  
TO PREVENT THE RISK OF ELECTRIC SHOCK, DO NOT REMOVE COVER (OR BACK). NO USER-SERVICEABLE PARTS INSIDE. REFER SERVICING TO QUALIFIED SERVICE PERSONNEL.

The exclamation point within an equilateral triangle is intended to alert the user to the presence of important operating and maintenance (servicing) instructions in the literature accompanying the appliance.

**NOTE:** This equipment has been tested and found to comply with the limits for a Class B digital device, pursuant to Part 15 of the FCC Rules. These limits are designed to provide reasonable protection against harmful interference in a residential installation. This equipment generates, uses, and can radiate radio frequency energy and, if not installed and used in accordance with the instructions, may cause harmful interference to radio communications. However, there is no guarantee that interference will not occur in a particular installation. If this equipment does cause harmful interference to radio or television reception, which can be determined by turning the equipment off and on, the user is encouraged to try to correct the interference by one or more of the following measures:

- Reorient or relocate the receiving antenna.
- Increase the separation between the equipment and receiver.
- Connect the equipment into an outlet on a circuit different from that to which the receiver is connected.
- Consult the dealer or an experienced radio/TV technician for help.

### Information to User

Alteration or modifications carried out without appropriate authorization may invalidate the user's right to operate the equipment.

## TWO VOLTAGE SELECTOR SWITCHES (Except Singaporean model)

**Only multi-voltage model is provided with this switch. Mains voltages in Saudi Arabia are 127 V and 220 V only. Never use this model with the 110 V setting in Saudi Arabia.**

The line voltage selector switches are on the rear panel. Check that they are set properly before plugging the power cord into the household wall socket. If the voltage is not properly set or if you move to an area where the voltage requirements differ, adjust the selector switches as follows.

1. Use a medium-size screwdriver.
2. First, insert the screwdriver in the groove of the voltage selector upper, and adjust so that the tip of the groove points to the voltage value of your area.
3. Next, insert the screwdriver in the groove of the voltage selector lower and adjust until the voltage is the same as at the right.

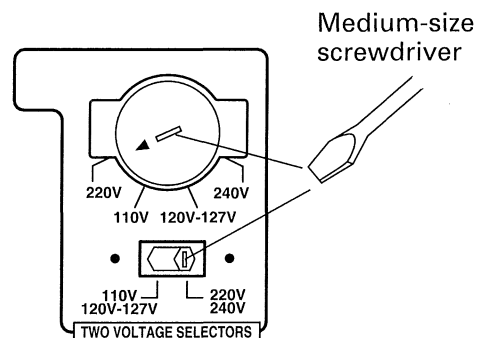

### CAUTION 220 V

Power source voltage is factory adjusted 220 volts. If your area is different, change voltage selectors settings.

# Quick Start Guide

This is a quick guide to setting up your new receiver so you can get home theater surround sound. For more details on any of the information presented here check the main section of the manual.

**Before making or changing the connections, switch off the power and disconnect the power cord from the AC wall outlet.**

## 1 Hooking Up Your DVD Player & TV

In order to use Dolby Digital/DTS/MPEG soundtracks which are at the heart of home theater you need to hook up your DVD player with digital audio connections. You can do this by either a coaxial or an optical connection, **you don't need to do both**. The quality of these two types of connections is the same but since some digital components only have one type of digital terminal you need to figure out which yours has and hook it up to the appropriate terminal on the receiver. In order to do this you will need the proper cable. For coaxial connections you can use a regular RCA stereo cord or the specially-made coaxial cords, they have the same type of plugs. For optical connections you will need a special optical cord which you can buy at your local stereo store. Also hook up the video connection of your DVD player, the analog audio (for recording the audio on DVDs, use regular RCA stereo cords), and your TV (it's easiest to use regular composite RCA video cords) as shown below. It is important that you hook up your TV (or monitor) in order to see a video image as well as the on screen displays (OSDs) shown by the VSX-D859TX/D859TXG (for more on p.16). We also recommend hooking up all your digital components to analog audio jacks as well. For this you can use regular RCA stereo cords.

### Digital Connection

If your DVD player has a coaxial terminal (not a PCM-only output) for the audio out hook up the receiver using that terminal. This is the best scenario, as you will be able to follow the default settings of this receiver and won't need to assign the digital inputs. If your DVD player has an optical terminal (not a PCM-only output) for the audio out you can hook up the receiver using that terminal. You will need to assign the digital input (tell the receiver which input you put your DVD digital audio into). See p. 5 for this. For either optical or coaxial connections follow the diagram below to make a digital connection between your DVD player and this receiver.

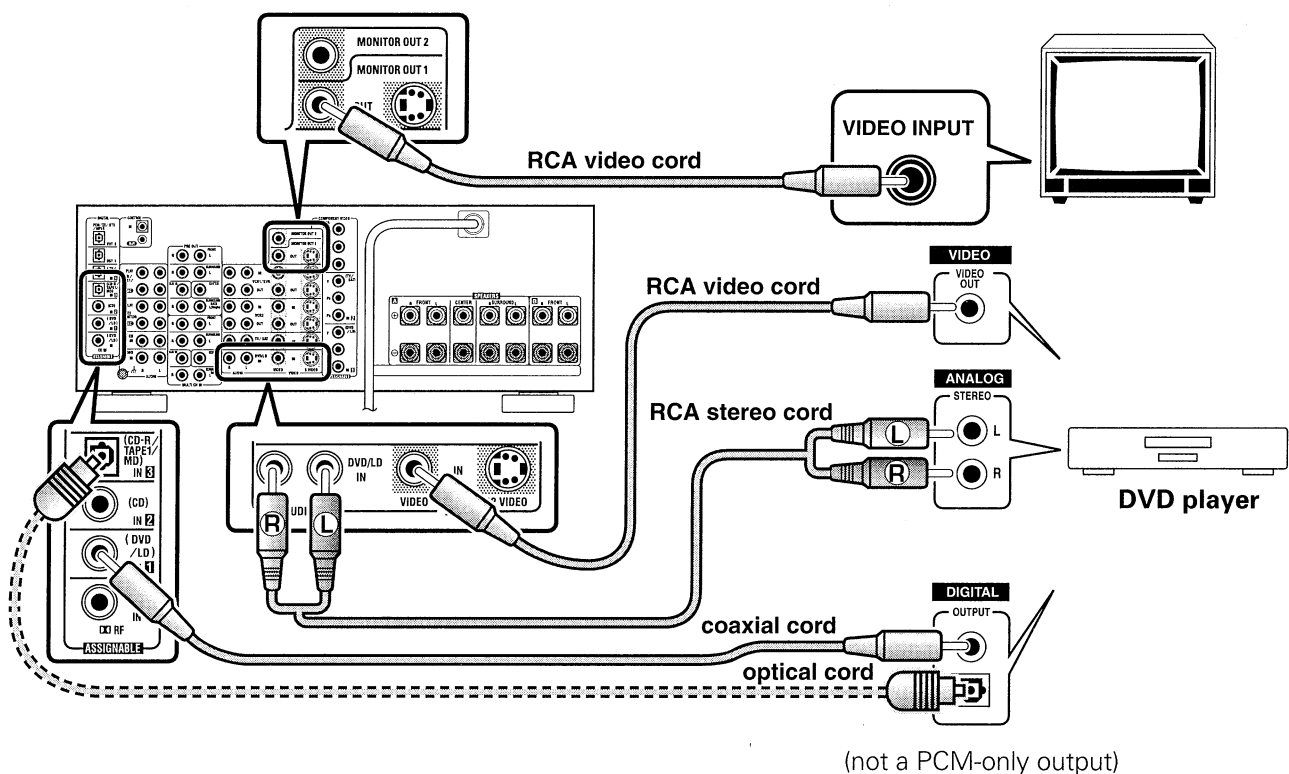

### 2 Speaker Connections

Home theater is designed to be set up with five, or seven speakers (front left & right; center; surround left & right; and, optimally, surround back left & right) and a subwoofer but you can use this receiver with fewer speakers.

Hook up the speakers you have to the SPEAKERS A terminals on the back of the receiver. If you only have two speakers hook them up as FRONT. If you have three, hook up the single speaker as CENTER. Follow the diagram below in order to hook up all your speakers. A center speaker is very important for watching films because the dialog comes from the center speaker in digital soundtracks. **If you do not have a CENTER speaker you must tell the receiver the CENTER channel is OFF or when you listen to digital soundtracks you won't hear any dialog.** Use the instructions on p. 33 – 34 in order to do this.

Follow the diagram below to hook up an additional amplifier in order to use surround back speakers. These speakers are important to hear all the sound channels on new, eight channel home theater DVDs. The diagram below also explains how to hook up a subwoofer which provides realistic bass sounds.

Make sure you connect the speaker on the right to the right terminal and the speaker on the left to the left terminal. Also make sure the positive and negative (+/-) terminals on the amplifier match those on the speakers.

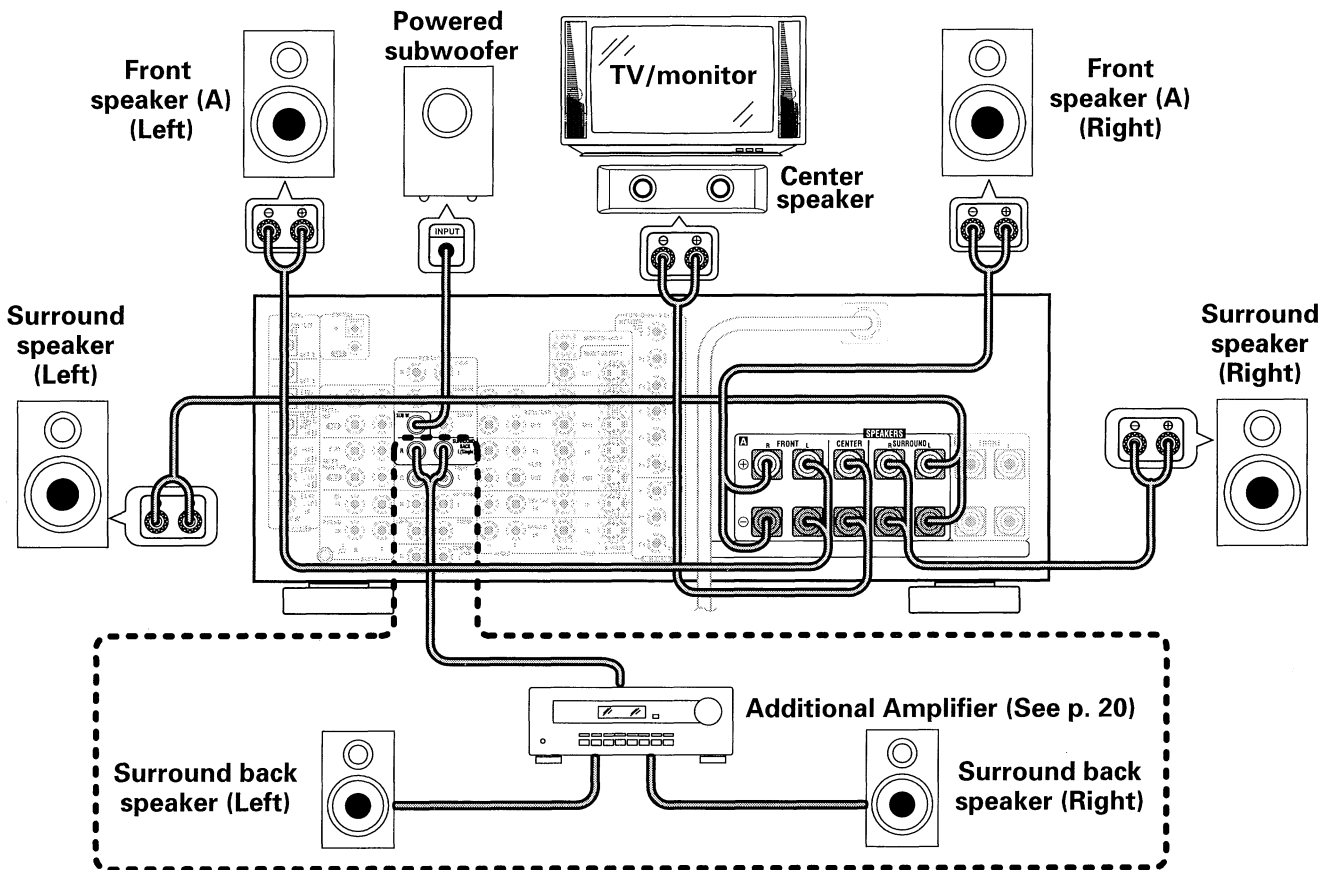

### 3 Setting up the Remote Control & Unit

**1 Put the batteries in the REMOTE CONTROL. (See p. 9)**

**2 Plug the main unit into a AC wall outlet.**

There are two buttons that affect the power. ON/OFF actually turns the power on/off and STANDBY/ON toggles between standby mode and the receiver fully on. When in standby mode you can turn the unit on with the remote control.

## 4 Digital Input Assignment

This is only necessary if you did not hook up your DVD to DIGITAL IN 1, as in the diagram on p. 3.

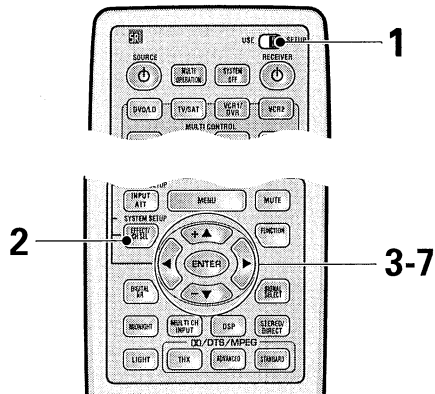

### 1 Set the remote control slide switch to SETUP.

Also make sure your TV is on and set to the receiver.

- When you're done setting up the receiver, remember to set the slide switch back to USE.

### 2 Press the SYSTEM SETUP button.

You should see the following display on your TV.

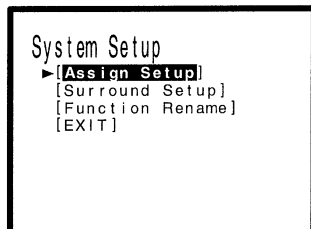

- You can escape from this screen at any time by pressing the SYSTEM SETUP button again. None of the settings you made will be entered in this case.

### 3 Assign Set up should be selected, if it isn't use the ▲/▼ buttons to select it. Press ENTER.

You should see the following display on your TV.

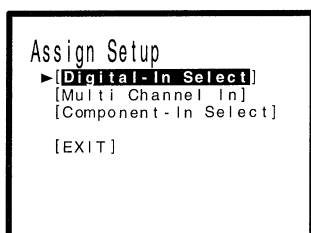

### 4 Digital in Select should be selected, if it isn't use the ▲/▼ buttons to select it. Press ENTER.

You should see the following display on your TV.

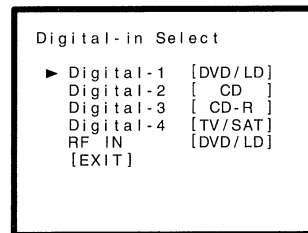

### 5 Choose the Digital-3 (or the digital in jack you connected your DVD to on page 3) you hooked up your DVD player to and assign "DVD/LD" to it.

- ① Use the ▲/▼ buttons to choose the Digital-3 and press ENTER.

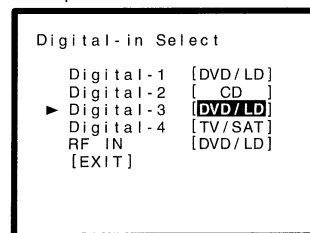

- ② Use the ▲/▼ buttons to choose the DVD/LD setting and press ENTER.

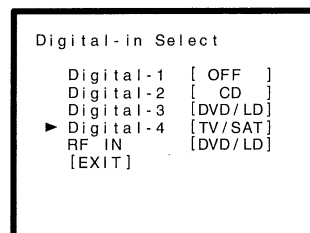

### 6 Select EXIT with ▲/▼ buttons and press ENTER to return to the Assign Setup menu.

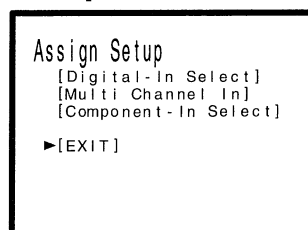

### 7 Select EXIT with ▲/▼ buttons and press ENTER to return to the System Setup menu.

### 5 Playing a DVD with Surround Sound

- 1 Turn on your TV, and the DVD player.
- 2 Set the remote control slide switch to USE.
- 3 Press the DVD/LD button on the remote control.  
You should see "DVD/LD" in the display on the receiver.
- 4 Press the STANDARD button for the basic surround sound setting.
- 5 Play a DVD.

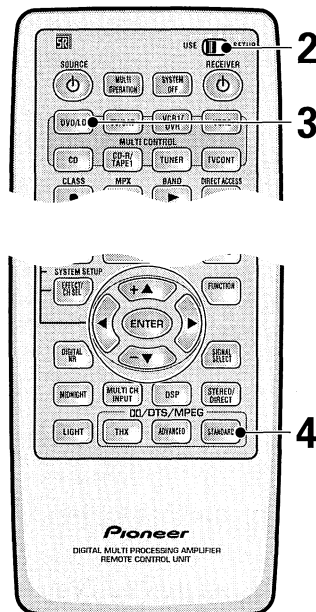

### 6 For Better Surround Sound

- 1 Go through the entire "Initial Set up" procedures as outlined on pages 26 – 40 of this instruction manual.  
If you don't hook up any other components with digital audio or do so following the default settings of the receiver (see page 12) you won't have to assign any more digital inputs, but many other adjustments are necessary and will improve the sound tremendously.
- 2 Experiment with the different sound settings offered with the **DD/DTS/MPEG** and **DSP** buttons.  
For more information see pages 41 – 45.
- 3 As mentioned above you should go through the "speaker setting" instructions on p. 27 – 34 to set up your speakers properly. If you don't do this you, at least, need to make sure the CENTER channel is turned off if you don't have a center speaker. Use the instructions on p. 33 – 34.

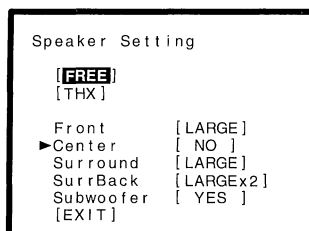

# Features

## Multi Channel Stereophonic Concept

The VSX-D859TX/D859TXG receivers are constructed with Pioneer's industry-leading multi channel stereophonic concept. This well-developed approach to receiver circuitry takes the high level base technology that, up until now, has been only used for stereo equipment and applies it to multi-channel audio-visual receivers. The result is that the product, in addition to being expertly built, and gives you optimal sound reproduction of DVDs, other multi channel sources and stereo sources as well. This receiver is designed capture to a true reproduction of the intentions of a filmmaker or music producer at the time they were mastering the soundtrack in the studio. It incorporates 5 independent 130 watt (Maximum Output Power) built in power amplifiers, with high-performance Hex power Direct Power MOS FET output transistors. The isolated chamber construction cuts off unwanted electrical influences from the digital circuitry and allows accurate representation of each channel for true high fidelity reproduction from even the most demanding Dolby Digital, DTS and MPEG program sources. In addition, the amplifier uses Direct Construction to give the purest sound available. All these elements consolidated in one receiver afford the listener a new surround sound experience in his or her home.

## Universal Player Compatibility

This receiver incorporates the latest technology and is able to handle cutting edge audio formats, like DVD Audio, which are just hitting the market. Its high compatibility offers a variety of inputs to decode all types of sources at the highest possible quality. The VSX-D859TX/D859TXG 's multi channel in connections lets you hook up eight discrete channels of audio. They also have multi channel direct inputs and the ability to decode the cutting edge formats.

## Decoding of Next Generation Digital Source Film Formats

Built into this the VSX-D859TX/D859TXG is the latest in film sound format technology. This technology includes the recent THX SURROUND EX and HOME THX CINEMA surround modes which employ special processing to allow you to enjoy movie soundtracks with the same level of power and realism you experience in well-designed movie theaters. The THX SURROUND EX mode has been especially designed to incorporate surround back channels that some new source material uses. The VSX-D859TX/D859TXG has the ability to decode Dolby Digital, Dolby Pro Logic, DTS (Digital Theater Systems) and MPEG sources, which are the standards of home theater today. It also offers component video terminals for the sharpest video transmission available to the consumer.

*Manufactured under license from Lucasfilm Ltd. U.S. patent numbers 5,043,970; 5,189,703; and/or 5,222,059. European patent number 0323830. Other U.S. and foreign patents pending. Lucasfilm and THX are trademarks of Lucasfilm Ltd. Surround EX is a trademark of Dolby Laboratories. Used under authorization.*

*"DTS", "ES" and "DTS Digital Surround" are trademarks of Digital Theater Systems, Inc. Manufactured under licence from Digital Theater Systems, Inc.*

*Manufactured under license from Dolby Laboratories. "Dolby", "Pro Logic" and the double-D symbol are trademarks of Dolby Laboratories. Confidential unpublished works. © 1992 - 1997 Dolby Laboratories. All rights reserved.*

## Advanced Theater Modes & DSP Surround Modes

Advanced Theater modes enhance the sound of either film or music so a more dramatic effect can be achieved. The four modes are each designed to accentuate specific sound qualities, giving the listener a wide range of possibilities. DSP (Digital Signal Processing) surround modes give you the capability of transforming your living room into seven different sonic environments when listening to music.

## Midnight Mode, Digital Noise Reduction & 7 Channel Tone Control

The Midnight mode allows you to obtain excellent surround sound effects even when listening at low volumes, something that was previously impossible. Digital noise reduction filters out unwanted noise from recordings to give you a clearer sound and the 7 channel tone control allows you to adjust the treble and bass of each channel individually to suit your listening tastes.

## The Energy-saving Design

This unit is designed to use less than 1 W of energy when the receiver is in standby mode.

# Table of Contents

<b>Quick Start Guide</b> .....	<b>3</b>	<b>Remote Control of Other Components</b> ...	<b>58</b>
<b>Features</b> .....	<b>7</b>	Setting Up the Remote Control to Control Other	
<b>Before You Start</b> .....	<b>9</b>	Components .....	58
Checking the Supplied Accessories .....	9	Clearing One of the Remote Control Settings .....	62
How to Use This Manual .....	9	Clearing All the Remote Control Settings .....	62
Preparing the Remote Control .....	9	Using the Remote Control with Other	
Opening the Front Panel .....	10	Components .....	63
Installing the Receiver .....	10	<b>Using Other Functions</b> .....	<b>70</b>
The PIONEER SR SYSTEM:		Recording from Audio Components .....	70
Operating other PIONEER components .....	10	Recording from Digital Audio Components .....	71
<b>Connecting Your Equipment</b> .....	<b>11</b>	Recording from Video Components .....	72
Audio Components .....	11	Function Rename .....	73
Digital Connections .....	12	Multi Operations .....	75
Example Connection for a DVD/LD or LD Player ....	13	System Off .....	78
Video Components .....	14	Direct Function .....	79
TV/ Satellite tuner Components .....	15	Remote Back Light .....	80
TV .....	16	Changing the Display .....	80
Multi Channel Input (External Decoder) .....	16	Video Select .....	81
Connecting the Radio Antennas .....	17	<b>Techno Tidbits &amp; Problem-solving</b> .....	<b>82</b>
Speakers .....	18	Dolby Digital .....	82
Placing Your Speakers .....	19	DTS .....	82
Connecting Additional Amplifiers .....	20	THX .....	83
Plugging In .....	20	MPEG Audio .....	84
<b>Displays &amp; Controls</b> .....	<b>21</b>	Preset Code List .....	85
Front Panel .....	21	Troubleshooting .....	88
Remote Control .....	23	Specifications .....	90
Display .....	25		
<b>Initial Set Up</b> .....	<b>26</b>		
On Screen Display .....	26		
Channel Step Setting .....	26		
Setting Up for Surround Sound .....	27		
<b>Basic Playback</b> .....	<b>41</b>		
Sound Modes .....	41		
Selecting a Sound Mode .....	44		
Playing Sources with Dolby Digital,			
DTS or MPEG Audio .....	45		
Playing Stereo Sources .....	46		
Switching Analog and Digital Signal Input .....	47		
Reducing Noise During Playback .....	48		
Listening in Midnight Mode .....	49		
Listening the Loudness Mode .....	49		
Adjusting Bass and Treble .....	50		
MULTI CHANNEL IN Playback .....	51		
96kHz 24bit Performance .....	51		
Direct Playback .....	52		
Adjusting the Brightness of the Display .....	52		
DUAL MONO setting .....	53		
<b>Using the Tuner</b> .....	<b>54</b>		
Automatic and Manual Tuning .....	54		
Direct Access Tuning .....	55		
Memorizing Frequently Used Stations .....	56		
Recalling Memorized Stations .....	57		



# Before You Start

## Checking the Supplied Accessories

Please check that you have received all of the following supplied accessories.

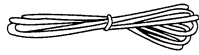

FM wire antenna

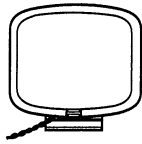

AM loop antenna

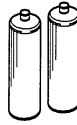

"AA" IEC LR6  
batteries x 2

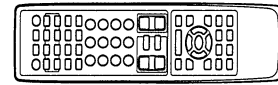

Remote control unit

- Operating Instructions

## How to Use This Manual

This manual is for the VSX-D859TX/D859TXG Audio/Video Multi-Channel Receiver.

This manual is divided into three main sections which will tell you how to setup and use the unit:

### PREPARATION

First carry out the tasks below in this "Before You Start" section to prepare the remote control, then connect the receiver to your other components as described in "Connecting Your Equipment" (p. 11). Take special care to connect your digital equipment like DVDs and LDs properly to be able to take advantage of the receiver's surround sound systems (p. 12 – 14). To learn about a specific button, control, or indicator, see "Displays & Controls" starting on p. 21.

### SET UP

Performing the tasks in "Initial Setup" (from p. 26) is essential to get proper surround sound.

### OPERATION

To play some music or soundtrack refer to "Basic Playback" starting on p. 41. "Using the Tuner" (p. 54) explains how to use the radio of this unit. Doing the operations in "Remote Control of Other Components" (p. 58) is highly recommended so you can use this unit's remote control for all your components. "Using Other Functions" (p. 70) explain the other possibilities of the receiver.

"Techno Tidbits & Problem-solving" (p. 82) provide detailed technical information and a troubleshooting guide.

The following marks and symbols are used throughout the manual:



Provides additional information, precautions, and advice.



Indicates a blinking button, indicator, or display.

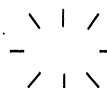

Indicates a steadily lit button, indicator, or display.

## Preparing the Remote Control

### Loading the batteries

Load the batteries into the remote control as shown below. Please use alkaline batteries. When you notice a decrease in the operating range of the remote control, replace all batteries with new ones.

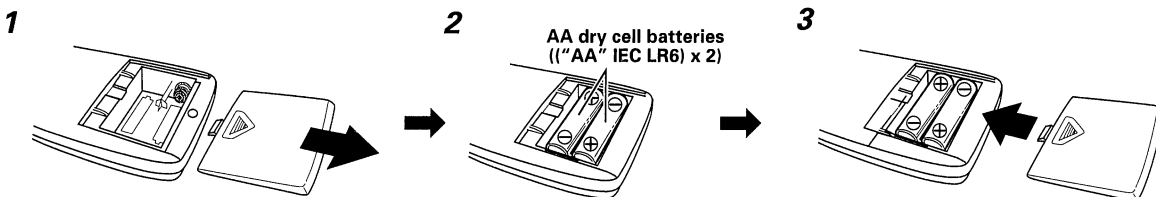

### CAUTION!

Incorrect use of batteries may result in such hazards as leakage and bursting. Observe the following precautions.

- Never use new and old batteries together.
- Insert the plus and minus sides of the batteries properly according to the marks in the battery case.
- Batteries with the same shape may have different voltages. Do not use different batteries together.
- When disposing of used batteries, please comply with governmental regulations or environmental public institution's rules that apply in your country or area.

## Before You Start

### Operating range of remote control unit

The area in which you can use the remote control to operate the VSX-D859TX/D859TXG is fairly large. To use, point the remote control toward the remote sensor on the front panel of this unit while within the range shown below.

Remote control may not function properly if:

- There are obstacles between the remote control and the remote sensor.
- Direct sunlight or fluorescent light is shining onto the remote sensor.
- The receiver located near a device emitting infrared rays.
- Operated simultaneously with another remote control which uses infrared rays.

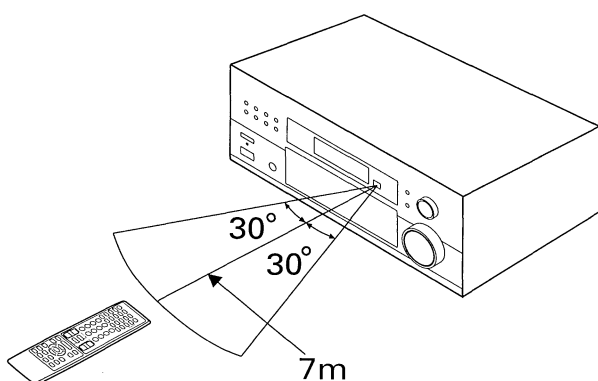

### Opening the Front Panel

To open the front panel push gently on the lower third of the panel with your finger.

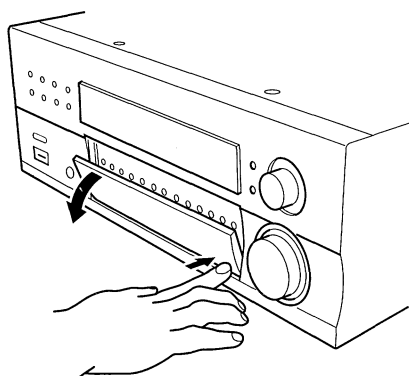

## Installing the Receiver

### Ventilation

- When installing this unit, make sure to leave space around the unit for ventilation to improve heat radiation (at least 60 cm at the top, 10 cm at the rear, and 30 cm at each side). If not enough space is provided between the unit and walls or other equipment, heat will build up inside, interfering with performance or causing malfunctions.
- Do not place on a thick carpet, bed, sofa or fabric having a thick pile. Do not cover with fabric or other covering. Anything that blocks ventilation will cause the internal temperature to rise, which may lead to breakdown or fire hazard.

## The PIONEER SR System:

### Operating other PIONEER components

Connecting an optional control cord allows you to operate other PIONEER components simply by pointing the receiver's remote control at the remote sensor on the front panel of the receiver. The receiver then sends the remote control signals to the other devices via the CONTROL OUT terminal.

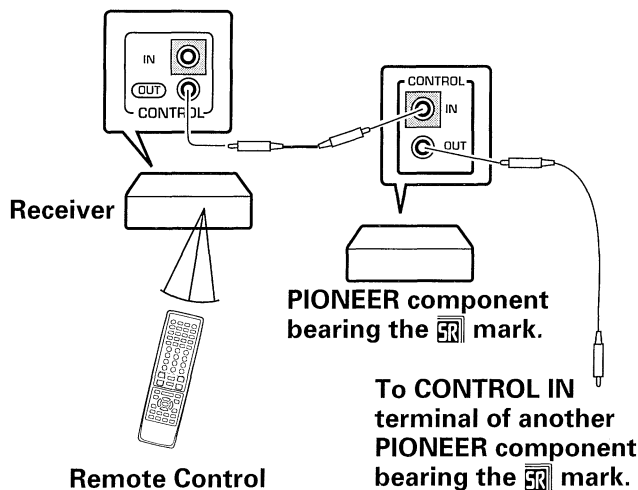

- You can also control PIONEER components (and those made by other manufacturers) by pointing the receiver's remote control directly at the respective component. This type of operation does not require control cords. All you have to do is recall the appropriate the stored settings (see p. 58 – 59).
- If you use a remote control hooked up via the CONTROL IN jack with a control cord, you won't be able to use this unit's remote control.

# Connecting Your Equipment

## Audio Components

To begin set up connect your audio components to the jacks as shown below. These are all analog connections and your analog audio components (turntable, cassette deck) use these jacks. Remember that for components you want to record with you need to hook up four plugs (a set of stereo ins and a set of stereo outs), but for components that only play (like a turntable) you only need to hook up one set of stereo plugs (two plugs). To use DTS, Dolby Digital or MPEG surround sound features you must hook up your digital audio components to the digital inputs (see p. 12). We also recommend hooking up your digital audio components to analog audio jacks. If you want to record to/from digital components (like a CD-R) to/from analog components you must hook up your digital equipment with these analog connections. See p. 13 & 15 for more on digital connections.

Before making or changing the connections, switch off the power and disconnect the power cord from the AC wall outlet.

\*The arrows indicate the direction of the audio signal.

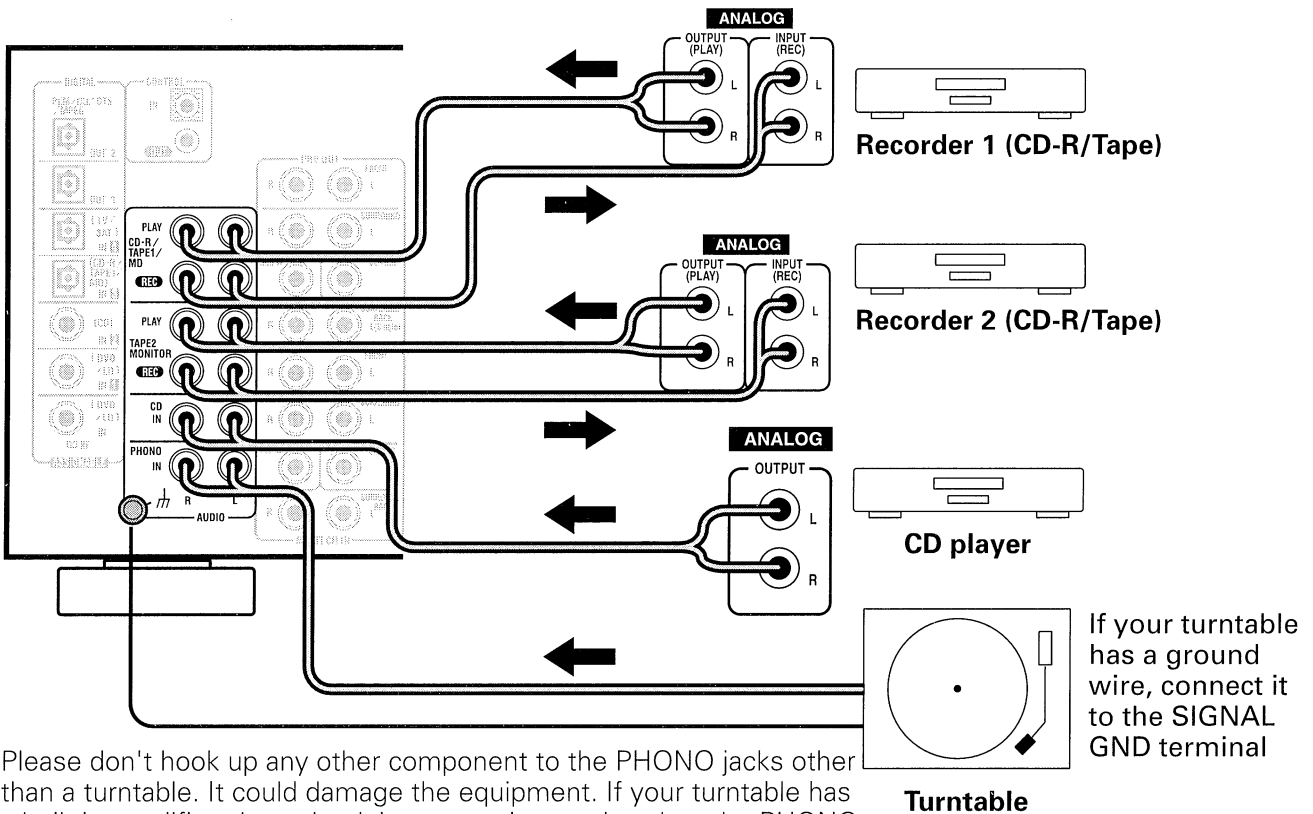

Please don't hook up any other component to the PHONO jacks other than a turntable. It could damage the equipment. If your turntable has a built-in amplifier please hook it up to an input other than the PHONO.

### ■ Analog audio/video cords

Use audio/video cords (not supplied) to make analog audio and video connections.

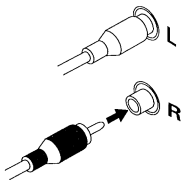

Connect red plugs to R (right) and white plugs to L (left).

Be sure to insert completely.

### Cassette deck placement

Depending on where the cassette deck is placed, noise may occur during playback of your cassette deck which is caused by leakage flux from the transformer in the receiver. If you experience noise, move the cassette deck farther away from the receiver.

### ■ Coaxial cords/Optical cables

Commercially available digital audio coaxial cords (standard video cords can also be used) or optical cables (not supplied) are used to connect digital components to this receiver. When you use optical digital input or output terminals, pull off the caps and insert the plugs. Be sure to insert completely.

### Digital audio coaxial cord (or standard video cord)

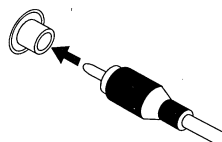

### Optical cable

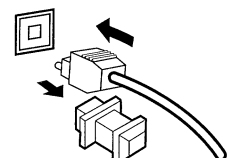

## Digital Connections

In order to use Dolby Digital/DTS/MPEG soundtracks which are at the heart of home theater you need to make digital audio connections. You can do this by either a coaxial or an optical connection (you don't need to do both). The quality of these two types of connections is the same but since some digital components only have one type of digital terminal, it is a matter of matching like with like (for example, the coaxial out from the component to coaxial in on the receiver). The VSX-D859TX/D859TXG has two coaxial and three optical inputs for a total of five digital inputs. In order to hook up a DVD/LD player or LD player see p.13. If possible hook up your digital equipment in accordance with this receiver's default settings, see "Digital Input Assignment," below, in order to do this. We also recommend hooking up your digital components to analog audio jacks in order to make recording from some digital sources which may be copy protected.

Connect your digital components as shown below.

There are two optical digital out jacks. The CD recorder is connected to one in the diagram below. If you connect this to the optical input on a digital recorder (currently these include MD, DAT and CD-R) you can make direct digital recordings with this unit.

Before making or changing the connections, switch off the power and disconnect the power cord from the AC wall outlet.

\*The arrows indicate the direction of the audio signal.

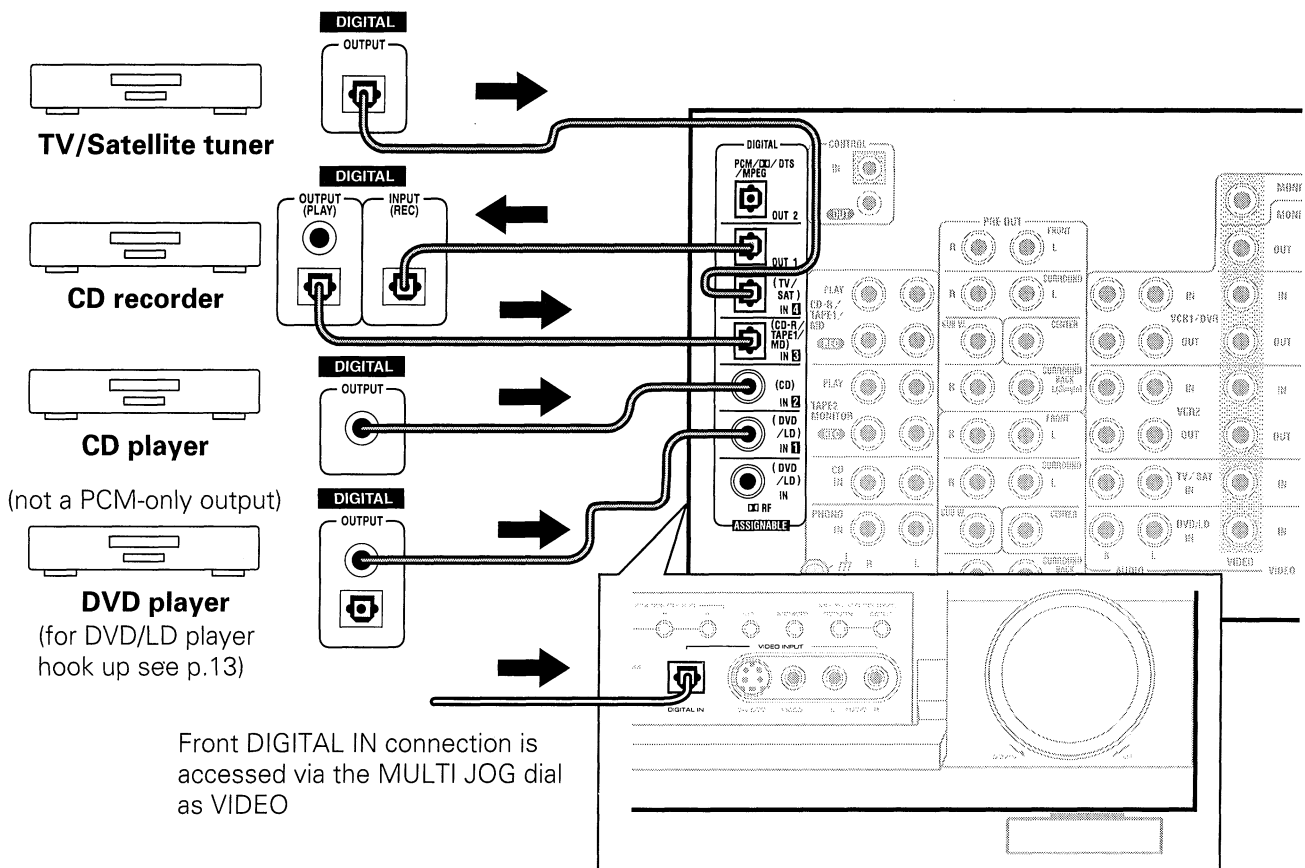

## Digital Input Assignment

Unlike analog connections, the jacks for digital connections are not dedicated to one type of component, they can be used freely. Thus you must tell the receiver what digital component in which jack so your components will be in sync with the names on the remote control buttons and the like. To avoid having to assign the digital inputs you can hook up your equipment in accordance with the receiver's default settings.

The default settings are:

**DIGITAL IN 1: DVD/LD**

**DIGITAL IN 3: CD-R**

**DIGITAL IN 2: CD**

**DIGITAL IN 4: TV/SAT**

You will notice that Digital IN 1, for example, is a coaxial jack. If your DVD/LD player only has an optical out jack on it then you won't be able to hook up your components in accordance with the default setting. In this case you will need to assign the digital inputs. See "Digital-In Select" on p. 30 in order to do this.

## Example Connection for a DVD/LD or LD Player

Since some LDs have soundtracks recorded on the special **DD** RF format you need to make special hook ups to ensure you can play all LDs on your system. If you don't have an LD (or an LD player with your DVD player) you don't need to worry about this. For the VSX-D859TX/D859TXG hook up your DVD/LD or LD player directly and make sure you make both a **DD** RF output and either a coaxial or optical digital connection. Of course you must hook up your DVD/LD or LD player with standard (coaxial or optical) digital connections but if you are able to hook up your player with a **DD** RF output (if your player has one) this will ensure you can use all LDs available. We also recommend hooking up your digital components to analog audio jacks as well. Before making or changing the connections, switch off the power and disconnect the power cord from the AC wall outlet.

\*The arrows indicate the direction of the audio signal.

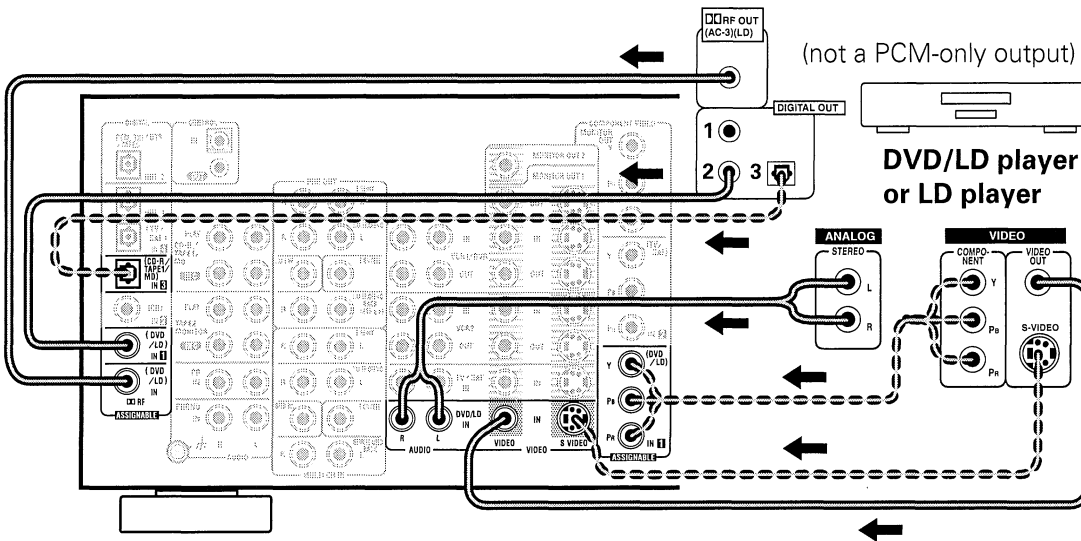

Be sure to make either a digital coaxial or digital optical connection as well, but you don't need to make both. Make sure the RF demodulator digital in switch is set correctly (optical or coaxial depending on the connection). Also, be sure to assign the jacks to the proper component(s) with the Digital-In Select procedure (see p. 30 if necessary). See the component's instruction manual if you are unsure about its input and output jacks.

## Connecting Your Equipment

### Video Components

Connect your video components to the jacks as shown below. Regarding a DVD there are three types of connections to make. Hook up your video signal with either component video, S-video, or composite video cords (the quality descends in this order) but remember, the video component you are watching and your TV must be hooked up with same type of video cord or you won't be able to see the picture. For the audio signal, order to use Dolby Digital/DTS/MPEG you must hook up a digital input. It is also a good idea to hook up your DVD components with analog audio connections as well, since some DVDs may not have a digital audio track. To cover all possible laser discs a DVD/LD player or LD player requires an analog connection and two digital connections (a coaxial or optical and a specialized RF demodulator connection, as explained on the previous page).

Before making or changing the connections, switch off the power and disconnect the power cord from the AC wall outlet.

\*The arrows indicate the direction of the audio & video signal.

### Connecting DVD players

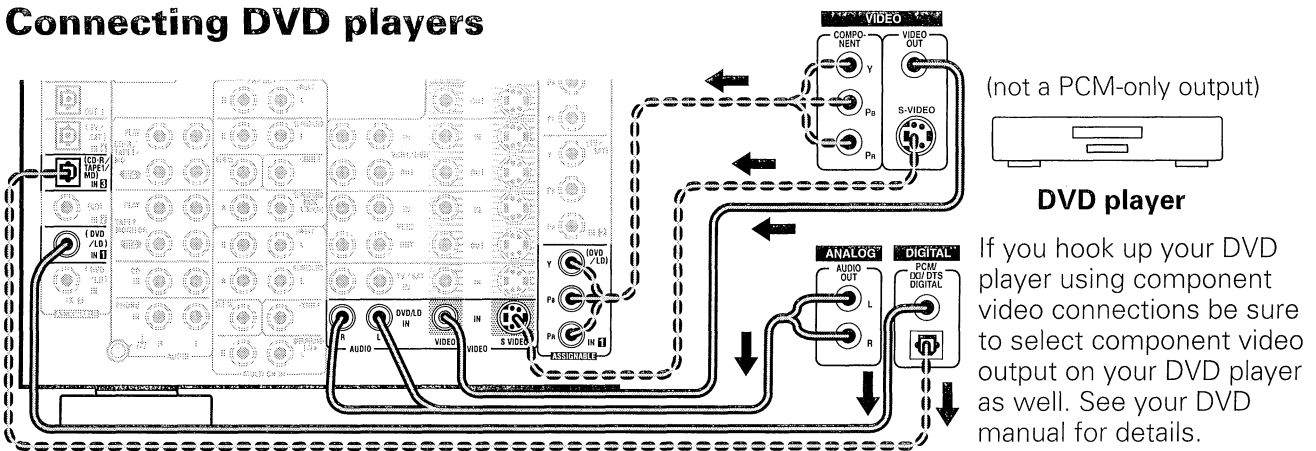

### Connecting VCRs or DVRs

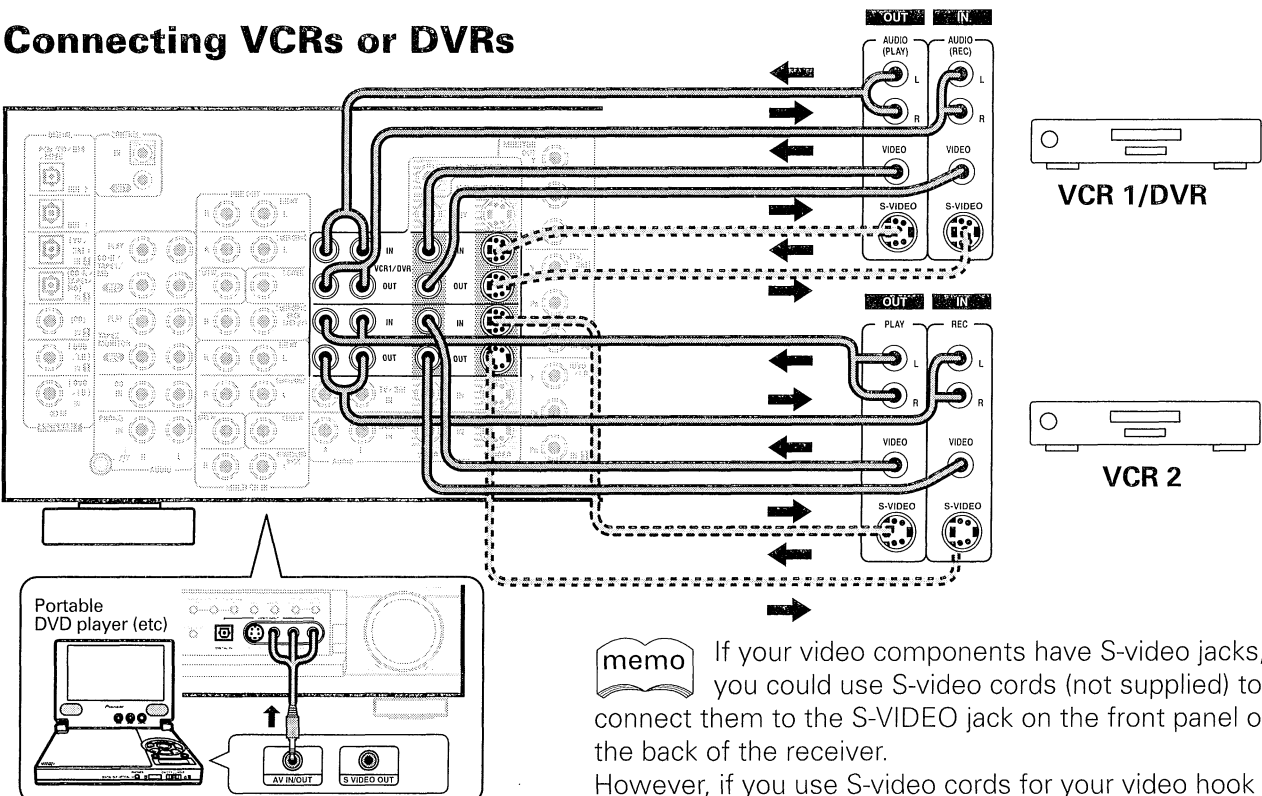

If your video components have S-video jacks, you could use S-video cords (not supplied) to connect them to the S-VIDEO jack on the front panel or the back of the receiver.

However, if you use S-video cords for your video hook ups you must also hook up your TV with S-video connections. Conversely, if you use regular composite video cords for video hook ups, you should use them for your TV as well.

Front panel video connections are accessed with the MULTI JOG dial as VIDEO.

## TV/ Satellite Tuner Components

Connect your satellite TV components to the jacks as shown below. Hook up the video signal with either component video, S-video, or composite video cords (the quality descends in this order) but remember, the video component you are watching and your TV must be hooked up with same type of video cord or you won't be able to see the picture. For the audio signal, order to use digital soundtracks (sometimes broadcast over digital satellite TV) you must hook up a digital input. Use either a coaxial or optical cables, it doesn't matter which (you don't need to use both). It's also a good idea to hook up your audio with analog cables (see below). This connection is called STEREO AUDIO OUT in the diagram. Before making or changing the connections, switch off the power and disconnect the power cord from the AC wall outlet.

\*The arrows indicate the direction of the TV signal.

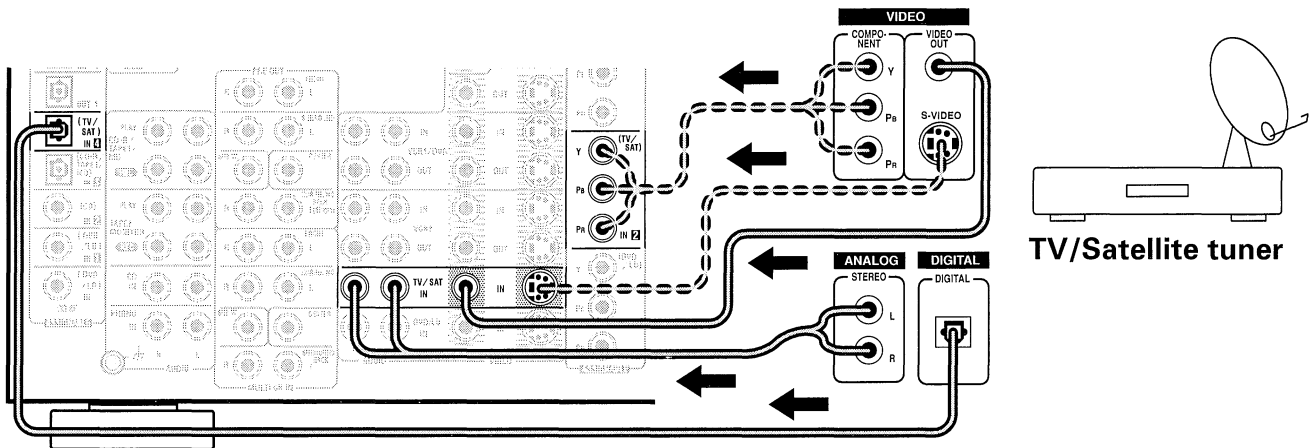

See the component's instruction manual if you are unsure about its input and output jacks.

### ■ S video cords

If you use S video cords (not supplied) to connect the video components be sure to insert completely.

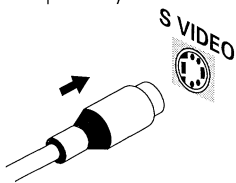

(See note on the previous page if you choose to use S-video connections.)

## Connecting Your Equipment

### TV

Connect your TV to the jacks as shown below. Hook up the signal with either component video, S-video, or composite video cords (the quality descends in this order) but remember, the video component you are watching and your TV must be hooked up with same type of video cord or you won't be able to see the picture. Before making or changing the connections, switch off the power and disconnect the power cord from the AC wall outlet.

\*The arrows indicate the direction of the TV signal.

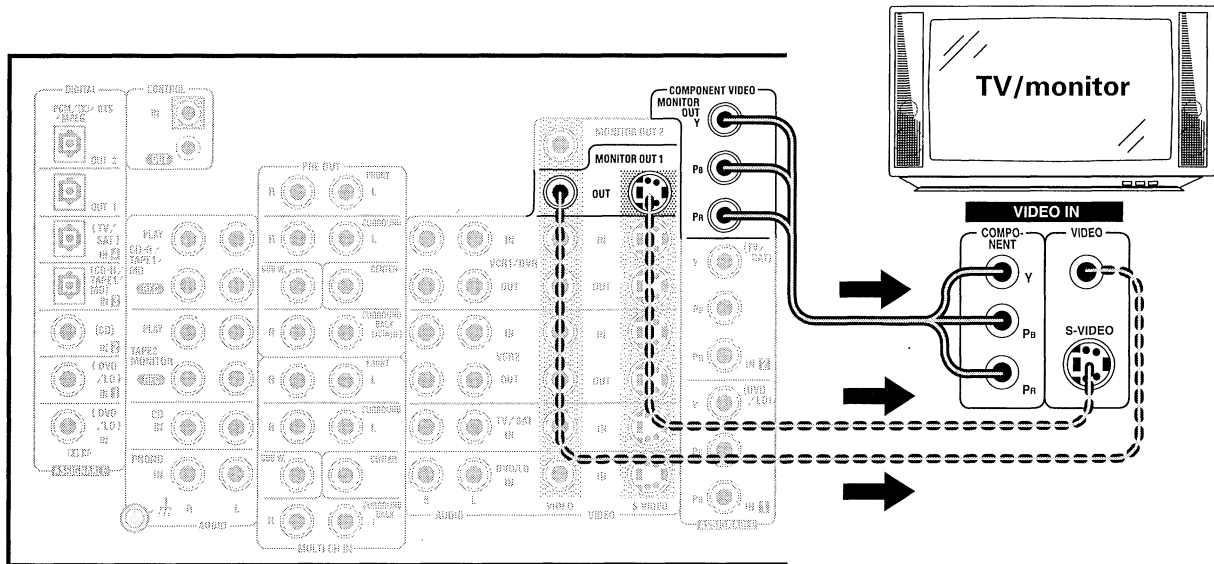

The COMPONENT VIDEO OUT jack can be used to get a TV picture but it doesn't show this receiver's on screen display (OSD).

### Multi Channel Input (External Decoder)

In some cases you may want to have your source material (DVD, etc) decoded externally. If you find you need a multi channel external decoder hook one up as shown below, but for most people this component is unnecessary (For more on this see p. 51). Before making or changing the connections, switch off the power and disconnect the power cord from the AC wall outlet.

\*The arrows indicate the direction of the video signal.

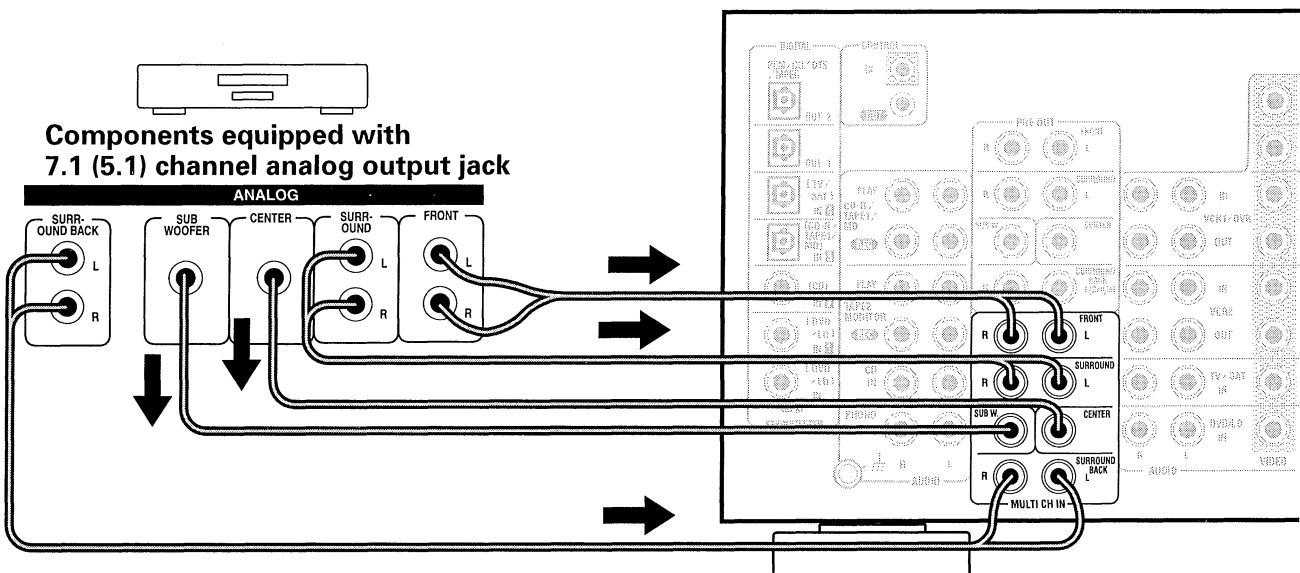



## Connecting the Radio Antennas

Connect the supplied FM wire antenna and the AM loop antenna to the antenna terminals as shown below. These antennas should provide adequate reception quality in most cases, but connecting outdoor antennas should noticeably improve sound quality. Before making or changing the connections, switch off the power and disconnect the power cord from the AC wall outlet.

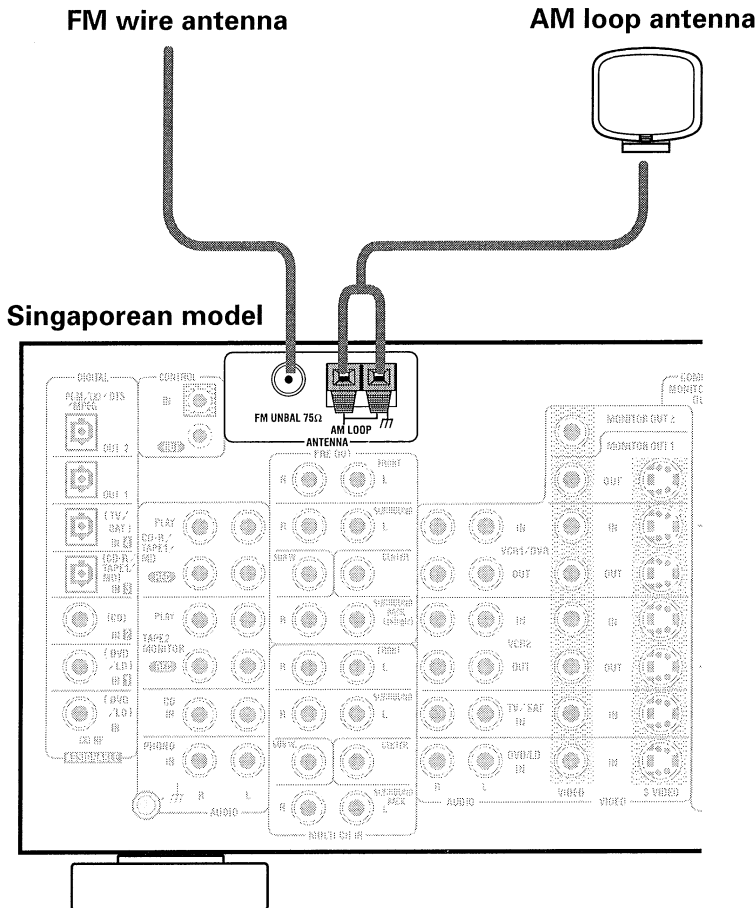

### ■ AM loop antenna

- 1 Assemble the antenna.

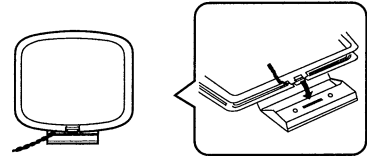

- 2 Twist exposed wire strands together and insert.

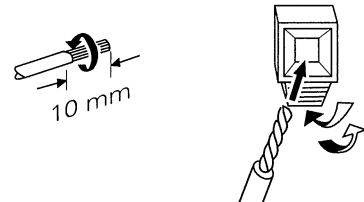

- 3 Attach to a wall, etc. (if desired) and face toward the direction providing the best reception.

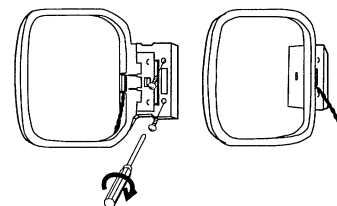

PREPARATION

## Using external antennas

### ■ To improve FM reception

Connect an external FM antenna.

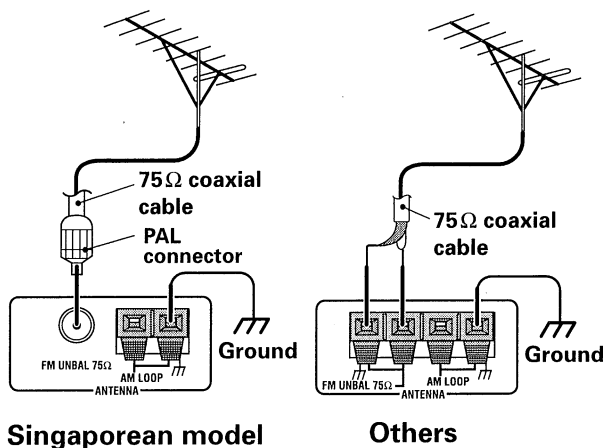

### ■ To improve AM reception

Connect a 5–6 meter length of vinyl-coated wire to the AM antenna terminal in addition to the supplied AM loop antenna.

For the best possible reception, suspend horizontally outdoors.

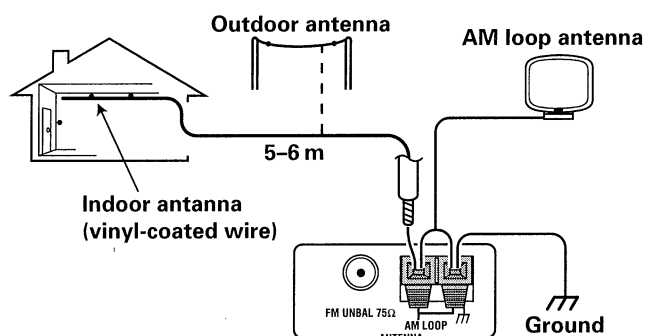

## Speakers

A full complement of eight speakers is best but, naturally, everyone's home set up will vary. Simply connect the speakers you have in the manner described below. The receiver will work with just two stereo speakers but it is designed to be used with at least three speakers.

One of the latest features of home theater is the use of SURROUND BACK speakers. These speakers add even greater realism in movie sound effects and new discs with soundtracks in Dolby Digital, DTS or MPEG incorporate these channels. In order to be able to use these channels you must hook your SURROUND BACK speakers up to an external amplifier and then connect that to the VSX-D859TX/D859TXG, as shown in the diagram on p. 4. If you only have one SURROUND BACK speaker hook it up to the SURROUND BACK L (SINGLE) terminal on the back of the receiver.

In general, make sure you connect the speaker on the right to the right terminal and the speaker on the left to the left terminal. Also make sure the positive and negative (+/-) terminals on the receiver match those on the speakers.

Before making or changing the connections, switch off the power and disconnect the power cord from the AC wall outlet.



The receiver has two speaker systems, A & B. A is the main system supporting the full complement of surround sound speakers. If you switch on both A & B speaker systems, only front speakers and the subwoofer will be audible. No sound will come from the center or surround speakers but multi channel sources will be down-mixed to the active speakers so no sound will be lost. Similarly, if you choose just the B system you'll only hear the front speakers connected to the B system and multi channel sources will be down-mixed to these two speakers.

You can use speakers with a nominal impedance rated 6Ω-16Ω, see below for more details.

### ■ Speaker terminals

- ① Twist exposed wire strands together.

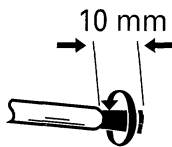

- ② Loosen speaker terminal and insert exposed wire.

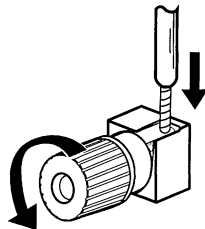

- ③ Tighten terminal.

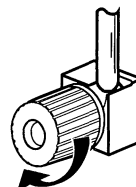

### Speaker impedance

You can change the speaker impedance for the VSX-D859TX/D859TXG but we recommend using speakers with an impedance of 8Ω-16Ω (the default setting). If you are using 6Ω- less than 8Ω impedance speakers, you need to change the impedance setting. Use any speaker rated between 6Ω-16Ω.

⏻ STANDBY/ON

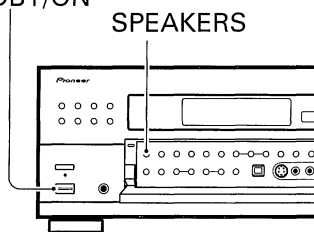

**First put the receiver in STANDBY mode, then press the power button while holding down the SPEAKERS button.**

The receiver will reset to the new impedance setting. You can choose the 8Ω-16Ω setting or the 6Ω-8Ω setting.



(This display indicates a 6Ω- less than 8Ω impedance setting.)

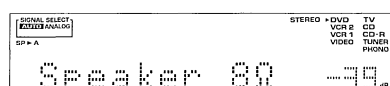

(This display indicates an 8Ω-16Ω impedance setting.)



To check which impedance setting to hold down the SPEAKERS button for 2-3 seconds. You'll get a display like the ones on the right telling you the speaker impedance setting.

## Placing Your Speakers

Proper speaker placement is essential to realize the best sound from your system. The diagram and tips given here are just a rough guide.

### Speaker placement

If you have a multiple speaker arrangement the placement of the speakers is extremely important. To achieve the best possible surround sound, install your speakers as shown below. Make sure all speakers are installed securely to prevent accidents and improve sound quality. Be sure to consult your speaker manuals for the best placement of the speakers. Some speakers are designed to be floor-standing but others benefit greatly from speaker stands which raise them off the floor.

#### VSX-D859TX/D859TXG with surround back speakers

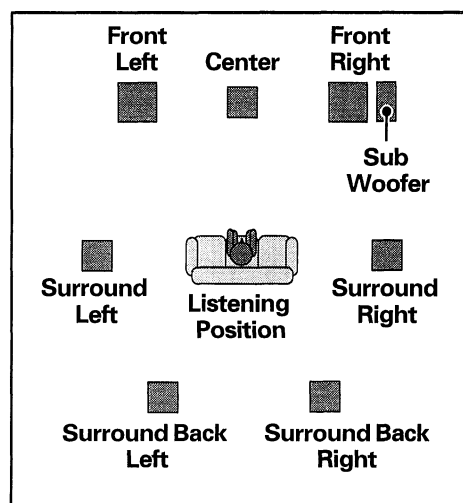
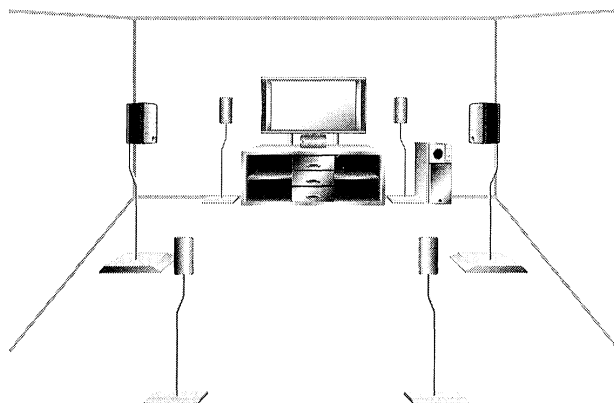

#### VSX-D859TX/D859TXG without surround back speakers

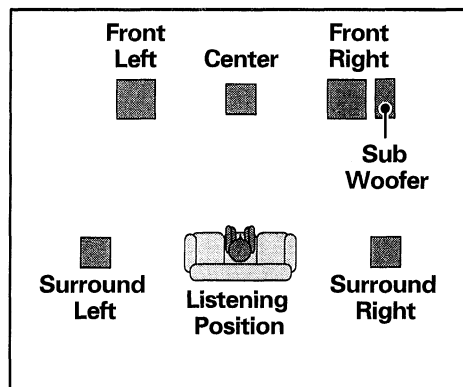
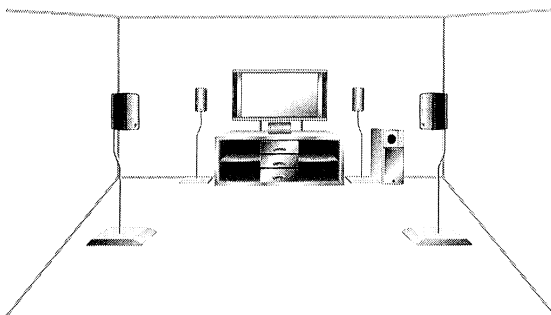

- Install the left and right front speakers at equal distances from the TV.
- When installing speakers near the TV, we recommend using magnetically shielded speakers to prevent possible interference such as distortion in the color of the TV screen. If you do not have magnetically shielded speakers and notice discoloration of the TV screen, place the speakers farther away from the TV.
- Install the center speaker above or below the TV so that the sound of the center channel is localized at the TV screen.
- If possible, install the surround speakers slightly above ear level.
- It may be difficult to obtain a cohesive surround effect if the surround speakers are installed farther away from the listening position than the front and center speakers.

#### CAUTION:

When installing the center speaker on top of the TV, be sure to secure it with tape or some other suitable means. Otherwise, the speaker may fall from the TV due to external shocks such as earthquakes, and it may lead to endangering those nearby or damaging the speaker.

## Connecting Your Equipment

### Connecting Additional Amplifiers

To hook up surround back speakers you need to use an additional amplifier. Other than for that purpose this receiver has more than sufficient power for any home use, but it is possible to add additional amplifiers to every channel of your system. Make the connections shown below to add amplifiers to power your speakers. Before making or changing the connections, switch off the power and disconnect the power cord from the AC wall outlet.

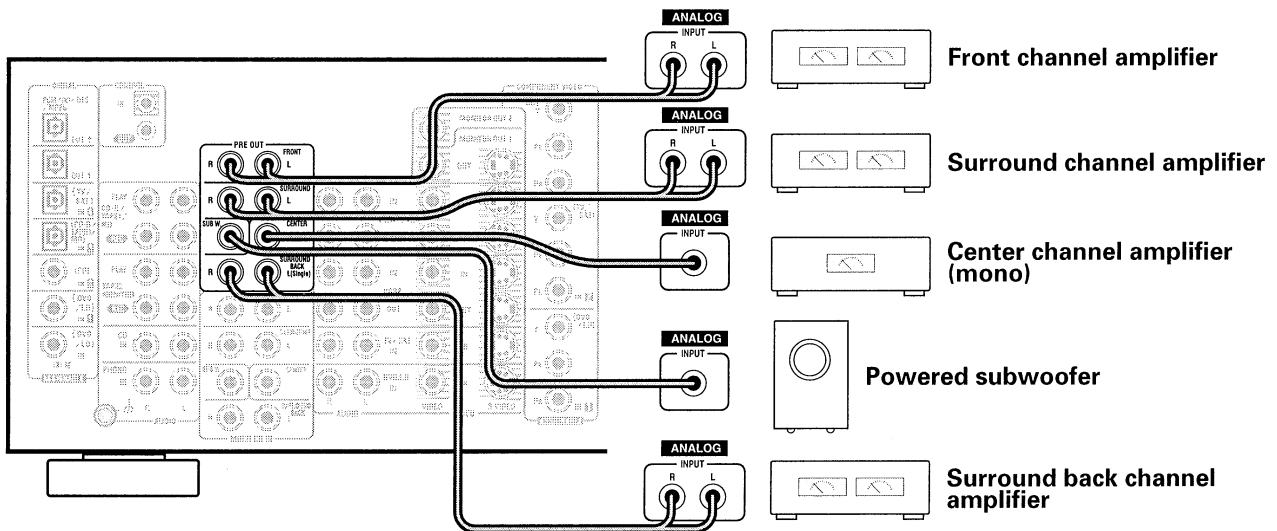

You can use the additional amplifier on the surround back channels for a single speaker as well. In this case plug the amplifier into the L (SINGLE) terminal only.

### Plugging In

Two components can be powered from this receiver. These outlets are switched, which means that power is switched on and off with the receiver. After connecting all your components, plug the receiver's power cord into a standard wall power outlet.

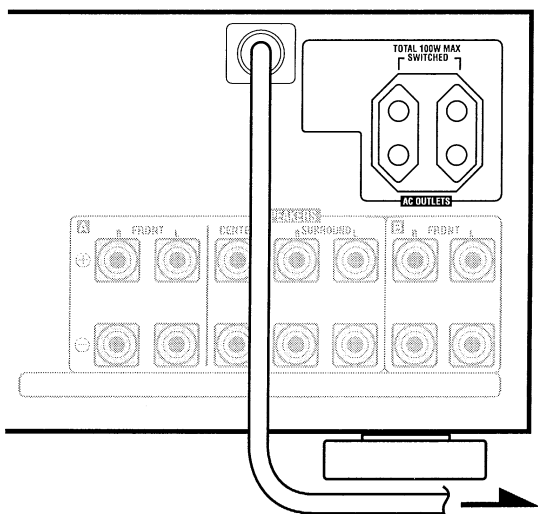

#### Caution!

Power consumption of any equipment connected to the **switched** power outlets should not exceed **100W**.

To avoid overheating, fire risk and possible malfunction, do not connect high-wattage appliances such as heaters, irons, monitors or TV sets to this unit's AC outlets.

Disconnect the receiver from the power outlet when it's not in regular use, for example, when on vacation.

#### Caution!

Do not connect a monitor or TV to this unit's AC OUTLETS.

# Displays & Controls

## Front Panel

All the controls on the front panel are explained and/or referenced here. To open the front panel push gently on the lower third of the panel.

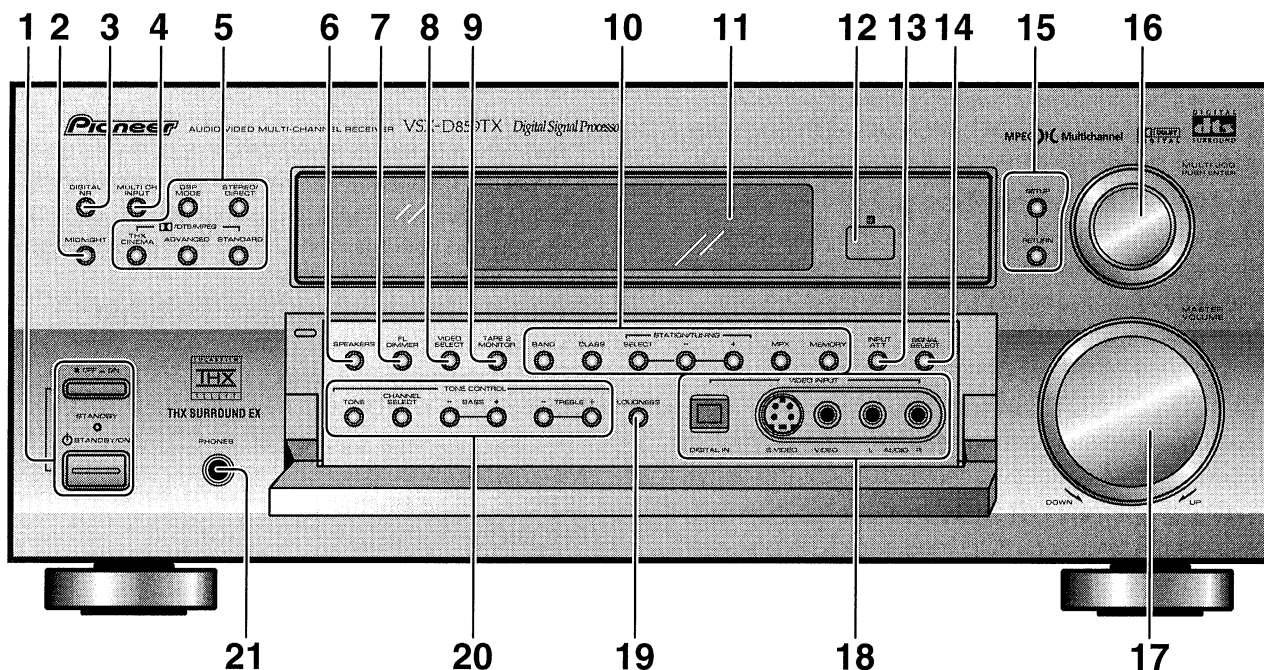

### 1 **STANDBY/ON button**

Press to switch the receiver ON or into STANDBY mode.

#### **STANDBY indicator**

Lights when the receiver is in STANDBY mode. (Please note that this receiver consumes a small amount of power [1.0 W] in the standby mode.)

#### **OFF ON button**

Press to feed power to the unit from the mains. Press again to cut power. When this is on you can use the remote control to turn on the unit. When this is off you can't use the remote control to turn the unit on.

### 2 **MIDNIGHT button (See p. 49)**

Switches the MIDNIGHT mode on or off (cannot be used in THX mode).

### 3 **DIGITAL NR button (See p. 48)**

Switches the DIGITAL NR on or off (cannot be used in THX mode).

### 4 **MULTI CH INPUT (See p. 51)**

Use to hook up an external component that can decode other types of signals and input them into the receiver.

### 5 **DSP MODE button (See p. 43 – 44)**

Press repeatedly to select a DSP sound mode. (HALL 1, HALL 2, JAZZ, DANCE, THEATER 1, or THEATER 2, 5/7 CH STEREO). Use these modes to produce surround sound from standard (two channel) stereo sources and create different listening environments.

### **STEREO/DIRECT button (See p. 43 & 52)**

Switches the receiver into STEREO mode if it was in a different sound mode (like ADVANCED THEATER) or toggles between DIRECT and STEREO mode. For more on STEREO mode see p. 43. DIRECT playback bypasses the tone controls, DNR, LOUDNESS, MIDNIGHT and channel level for the most accurate reproduction of a program source.

### **DTS/ DTS/ MPEG buttons (See p. 41 – 44, 82– 84)**

**THX CINEMA** – Cycles through the THX CINEMA, THX SURROUND EX or THX AUTO sound modes. Use when listening THX-certified sources, if you have THX-certified speaker setup or want to re-create a THX-style sound environment. It is also appropriate for Dolby Digital, Dolby Pro Logic, DTS or MPEG sources. Those with surround back speakers can use all three THX modes, those without can only use the THX CINEMA mode.

**ADVANCED THEATER** – Use to select one of the four Advanced Theater modes. Use to create certain types of sound environments when listening to Dolby Digital, Dolby Pro Logic, DTS or MPEG sources.

**STANDARD** – Use for pure decoding of multi channel sources, especially Dolby Digital, Dolby Pro Logic, DTS or MPEG software.

## Displays & Controls

### 6 **SPEAKERS (A/B) button**

Use to select the speaker system. A is the primary setting. It plays all speakers hooked up to the A system. A & B setting only plays the front speakers of both the A & B systems and the subwoofer.

Multi channel sources will be down-mixed to these speakers so no sound will be lost. B setting only plays the front speakers connected to the B system and multi channel sources will be down-mixed to these two speakers. The button cycles through the speaker systems as follows: A ⇒ B ⇒ A&B ⇒ off

### 7 **FL DIMMER button (See p. 52)**

Use to adjust the brightness of the fluorescent display (FL = fluorescent display). Four levels of the brightness ranging from very dim to very bright can be selected. Each press changes the brightness of the display.

### 8 **VIDEO SELECT button**

Switches the receiver between the various types of video input while keeping the audio input the same.

### 9 **TAPE 2 MONITOR button (See p. 70)**

Selects the tape deck (MD recorder, etc.) connected to the TAPE 2 MONITOR inputs/outputs. Allows monitoring of a recording as it's being made.

### 10 **TUNER CONTROL buttons (See p. 54-57)**

**BAND button** – Press to select the AM or FM band.

**CLASS button** – Press repeatedly to switch the preset station classes.

**TUNING SELECT** – Switches the STATION/TUNING button between station memory and frequency select modes.

**STATION -/+ button** – Use to choose programmed radio stations.

**TUNING -/+ button** – Use to manually tune to radio stations.

**MPX** – Press to switch between auto stereo and MONO reception of FM broadcasts. When the broadcast signal is weak, selecting MONO will improve the sound quality.

**MEMORY button** – Press to start the memorization of a preset station.

### 11 **Display (See p. 25)**

### 12 **Remote sensor**

Point the remote control toward the remote sensor to operate the receiver.

### 13 **INPUT ATT button**

Use to lower the input level of an analog signal that is too powerful, thus causing the sound to distort (the OVERLOAD indicator will light).

### 14 **SIGNAL SELECT button**

Press SIGNAL SELECT repeatedly to select one of the following:

**ANALOG** – Analog signal.

**DIGITAL** – Digital signal (DVD/LD, TV/SAT, CD, CD-R/TAPE 1/MD, VCR 1/DVR, VCR 2).

**RF** – RF signal (DVD/LD, TV/SAT, VCR 1, VCR 2, VIDEO).

**AUTO** – This is the default. If there are analog, RF or digital signals input the receiver automatically selects the best possible signal.

### 15 **MULTI-JOG CONTROL buttons**

**SETUP** – Press to switch the setup mode.

**RETURN** – Press to move back one step in the SETUP process.

### 16 **MULTI JOG dial**

You can use this dial for three purposes. In normal mode turn it to select a source component or press it to switch the display between function mode and sound mode. When you press the SETUP button (15), you can use it to perform SETUP operations (turn to select, push to enter).

**DVD/LD** – DVD player or laser disc player.

**TV/SAT** – TV or satellite tuner.

**CD** – Compact Disc player.

**CD-R /TAPE1/MD** – CD recorder, tape deck or mini disc recorder connected to CD-R/TAPE 1/ MD inputs/outputs.

**TUNER** – The built-in tuner.

**PHONO** – Turntable.

**VIDEO** – Video camera (etc.) connected to the VIDEO INPUT on the front panel.

**VCR1/DVR** – Video cassette recorder connected to VCR1/DVR inputs.

**VCR 2** – Video cassette recorder or other component connected to VCR 2 inputs.

### 17 **MASTER VOLUME**

Adjusts the overall receiver volume.

### 18 **VIDEO INPUT jacks (See p. 14)**

**DIGITAL IN** : Optical input for connecting a video game, portable DVD, etc., that has an optical out.

**S-VIDEO** : Video input for connecting a portable DVD player or game (etc.), that has an S-Video out.

**VIDEO / AUDIO (L/R)** : Video input for connecting a portable DVD player or game (etc.) that has standard video/audio outputs.

### 19 **LOUDNESS button (See p. 49)**

Switches the LOUDNESS mode on or off (cannot be used in THX mode).

### 20 **TONE buttons**

This button has two functions. Firstly, it switches between TONE on and TONE BYPASS, which bypasses the tone circuitry. Secondly, you need to press the button before using the CHANNEL SELECT buttons to adjust the BASS & TREBLE (cannot be used in THX mode).

### **CHANNEL SELECT button**

Switches the tone adjust controls between the FRONT, CENTER, SURROUND and SURROUND BACK speakers. You can then use the BASS and TREBLE controls to adjust the sound.

### **BASS (-/+) buttons (See p. 50)**

Use to adjust the low frequencies.

### **TREBLE (-/+) buttons (See p. 50)**

Use to adjust the high frequencies.

### 21 **PHONES jack**

Connect headphones for private listening (no sound will be heard through the speakers).

# Remote Control

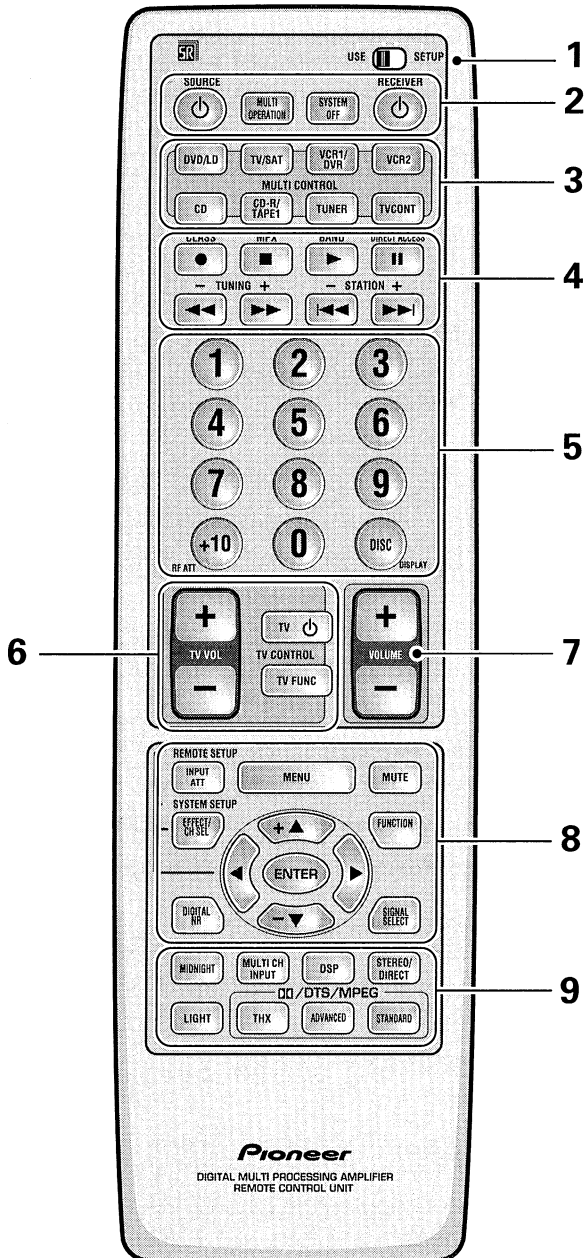

- 1 USE/SETUP slide switch**  
Use to put the remote into receiver SETUP, or receiver USE mode.
- 2 SOURCE button**  
Use to turn on the power of your other components after you have recalled or taught the signals to this remote control.

## MULTI OPERATION button

Use this button to start the MULTI OPERATION mode. See p. 75 – 76 for how to program and use the MULTI OPERATION mode.

## SYSTEM OFF button

This button turns off components in two ways. First, when pressed it will turn off all PIONEER components. Secondly, any component that has programmed into the MULTI OPERATIONS settings will also be turned off (see p. 79).

For example: If you programmed power on for your TV and VCR, pressing the SYSTEM OFF button will turn off these components even if they are not PIONEER products.

## RECEIVER button

Press to turn power of the receiver on or to STANDBY (off).

## MULTI CONTROL buttons

Use these to select a source and the corresponding remote operation mode.

For example, pressing TUNER selects the built in tuner and sets the remote operation to the tuner functions.

## Component Control buttons

Use to control specific components, like a CD player or DVD player, after you have programmed the remote control to do these operations (see pages 63 – 69) and the remote is put in that operation mode.

### [Tuner control]

**CLASS** – Press repeatedly to switch the preset station classes.

**MPX** – Press to switch between auto stereo and mono reception of FM broadcasts.

**BAND** – Press to select AM or FM band.

**DIRECT ACCESS** – Press to activate the direct access tuning mode.

**TUNING +/-** – Use to manually tune in to radio stations.

**STATION +/-** – Use to choose programmed radio stations.

## Number buttons

These buttons can perform a variety of different functions depending on the remote operation mode. They are most useful for CD and tuner operations.

## TV CONTROL buttons

The following buttons are used to control the TV only and can be used no matter what function the remote control is set to.

## Displays & Controls

**TV  button** – Press to turn the power of the TV on/off.

**TV FUNC button** – Press TV FUNC to select the TV for remote control operation.

**TV VOL +/- button** – Use to adjust the TV volume.

### 7 MASTER VOLUME buttons

Use to raise or lower the volume of the receiver.

### 8 INPUT ATT button (when USE mode is selected)

Use to lower the input level of an analog signal that is too powerful, thus causing the sound to distort (the OVERLOAD indicator will light).

### REMOTE SETUP button (when SETUP mode is selected)

Use to customize the remote control functions and the remote control itself. (See "Setting Up the Remote Control to Control Other Components" starting on p. 58, "Multi Operations" starting on p. 75.)

### MENU button

Use to get the various menus for your DVD or TV.

### MUTE button

Press to mute or restore the volume.

### EFFECT/CH SEL (when USE mode is selected) button

**EFFECT** – Use these buttons to increase or decrease the amount of effect applied in a DSP or Advanced Theater mode. When the amount of effect is increased in a DSP/Advanced Theater mode the characteristics of that mode become stronger and more noticeable. The scale ranges from 10-90 with 70 as the default setting. First turn on the DSP/Advanced Theater you want (by pressing the DSP/Advanced Theater button until you get the mode) and then increase or decrease the amount of effect.

**CH SEL** – You may want to adjust the channels when listening to some sound sources. Use this button to select the channel you want to adjust.

### SYSTEM SET UP button (when SETUP mode is selected)

Use to set up the speaker and sound systems. For more information see "Setting up for Surround Sound" starting on p. 27.

### FUNCTION button

Press to select a source. The button will cycle through all the possible sources.

### ▲(+)/▼(-)/◀/▶/ENTER buttons

Use to operate the on-screen menu on your TV screen and enter commands when setting up surround sound, speakers levels & settings, and other set up features see p. 27 – 40).

They also can be used to operate DVD players, DTVs and other components after you have input the components preset codes.

Specific use of these buttons is described in conjunction with the operations they perform. For more information see each individual section.

### DIGITAL NR button



Press to switch Digital NR on or off. (See p. 48)

### SIGNAL SELECT button (See p. 47)

Press SIGNAL SELECT repeatedly to select one of the following:

**ANALOG** – Analog signal.

**DIGITAL** – Digital signal (DVD/LD, TV/SAT, CD, CD-R/TAPE 1/MD, VCR 1/DVR, VCR 2, VIDEO).

 **RF** –  RF signal (DVD/LD, TV/SAT, VCR 1, VCR 2).

**AUTO** – This is the default. If there are analog, RF or digital signals input the receiver automatically selects the best possible signal.

### 9 MIDNIGHT button (See p. 49)

Switches the MIDNIGHT mode on or off.

### MULTI CH INPUT button (See p. 31, 51)

Press to switch to multi channel input mode.

### DSP button (See p. 43 – 44)

Press to select a DSP sound mode. Repeated presses cycle through the different possible DSP modes.

### STEREO/DIRECT button (See p. 43 & 52)

Switches the receiver into STEREO mode if it was in a different sound mode (like ADVANCED THEATER) or toggles between DIRECT and STEREO mode. For more on STEREO mode see p. 43. DIRECT playback bypasses the tone controls and channel level for the most accurate reproduction of a program source.

### LIGHT button

Press to light the remote control buttons.

### /DTS/MPEG buttons (See p. 41 – 44)

Press these buttons to put the receiver in the selected sound mode. For more information on these specific sound modes see p. 82 – 84.



# Display

All the display information is explained and/or referenced here.

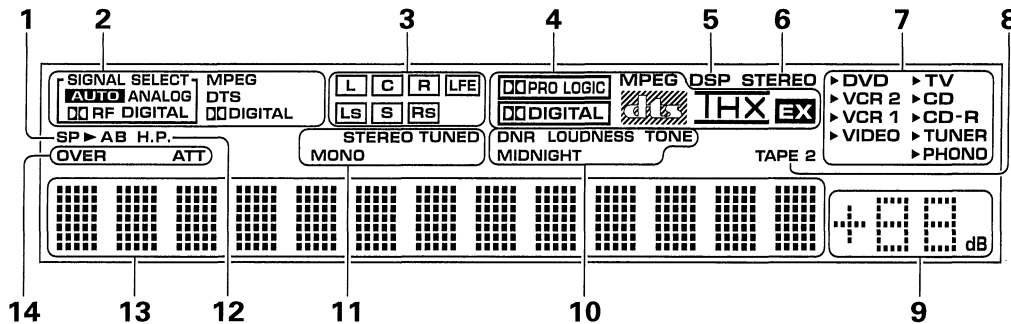

## 1 Speaker indicators

Light to indicate the current speaker system, A and/or B.

## 2 SIGNAL SELECT indicators

Light to indicate the input signal you selected.

## 3 Program Format indicator

For Dolby Digital, DTS or MPEG sources, these indicators change according to which channels are active in the source. When all three LS (left surround), S (surround) and RS (right surround) light at the same time it means a DOLBY SURROUND EX source, a DTS ES source, or an MPEG source with surround back channels is being used.

**L** – Left front channel.

**C** – Center channel.

**R** – Right front channel.

**LS** – Left surround channel.

**S** – Surround channel (mono).

**RS** – Right surround channel.

**LFE** – Low Frequency Effects channel.

## 4 DIGITAL/dts/MPEG mode indicators

**DIGITAL** – Indicates multi channel playback of a Dolby Digital source.

**PRO LOGIC** – Lights when Dolby Pro Logic decoding is switched on.

**DTS** – Indicates a DTS encoded source.

**THX** – Lights when the HOME THX CINEMA mode is selected.

**EX** – Lights when decoding a Surround EX source.

## MPEG Format indicators

Lights when decoding an MPEG format disc.

## 5 DSP indicator (See p. 41 – 44)

Lights when a DSP or Advanced Theater mode is selected.

## 6 STEREO indicator

Lights when a STEREO mode is selected.

## 7 Source indicators

▶ indicator lights at the selected source.

## 8 TAPE 2 indicator

Lights when the TAPE 2 monitor is on.

## 9 MASTER VOLUME indicator

Displays current volume level.

## 10 Sound control indicators

**DNR** – Lights when the digital NR is on.

**LOUDNESS** – Lights when the Loudness is on.

**TONE** – Lights when the Tone control is on.

**MIDNIGHT** – Lights when the Midnight mode is on.

## 11 Tuner indicators

**STEREO** – Lights when a FM stereo broadcast is received in the auto stereo mode.

**TUNED** – Lights when a broadcast is received.

**MONO** – Lights when the tuner is set to receive FM broadcasts with the mono mode selected.

## 12 H.P (headphones)

Lights when headphones are connected to the PHONES jack (speakers systems A and B both turn off automatically).

## 13 Character display

Shows current function or sound mode, status, etc.

## 14 Analog level indicators

**OVER** – When the source signal is analog, this lights if the signal is in danger of distorting.

Press INPUT ATT to lower the signal level.

**ATT** – Lights when INPUT ATT is used to reduce the level of the analog source signal.

# Initial Set up

## On Screen Display

There are a number of possible ways to hook up the receiver to your video components, like a DVD player, and hook up to your receiver to your TV, but some of them will not allow you to use the on-screen display of this unit. To avoid this, you simply need to keep the following rules:

- ① Always use the same type of video cords to hook up your video components to the receiver as you use to hook up the receiver to your TV. For example, if you use composite video cords to hook up your DVD player to the receiver, use composite video cords to hook up the receiver to your TV. If you use S video cords to hook up your DVD player and the receiver, use S video cords to hook up the receiver to your TV.
- ② Always make sure your TV is set to the appropriate input channel (for example, video 1). Your TV may have a number of input channels and if you do not select the proper one, you will not be able to use this receiver's on-screen display, or, in fact see any picture from this receiver at all. If you are unsure how to choose an input channel for your TV, refer to the manual which came with your TV.

## Switching video system between PAL and NTSC (if necessary)

This receiver is able to use two types of video systems for its OSD (on screen display) either PAL or NTSC. If you don't match the system on the amplifier with your home system no OSD will appear on your TV. The default setting is PAL. If you use this system you don't need to make any settings here. People with multi-system TVs don't need to worry about changing the setting either. If necessary, follow the instructions below to switch the type of video system.

⏻ STANDBY/ON

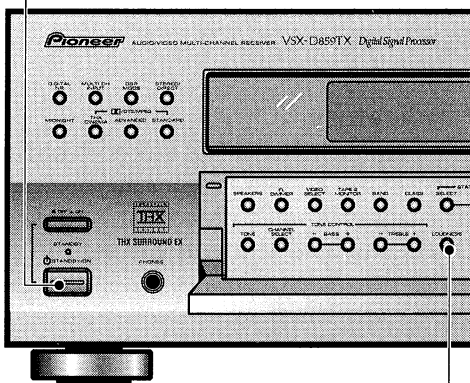

LOUDNESS

### 1 Put the receiver in the STANDBY mode.

### 2 While holding down the LOUDNESS button press the ⏻ STANDBY/ON button.

The video system type will change depending on the state the receiver was previously in. The new type, either PAL or NTSC, will appear in the display. It will be shown for about seven seconds and then the receiver returns to normal operating mode.

To change the video system type again repeat steps 1 and 2.

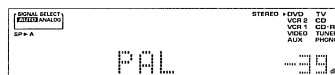

When a PAL system is selected

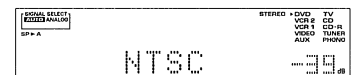

When a NTSC system is selected

## Channel Step Setting (Except Singaporean model)

The unit has been factory preset to the channel allocation value for the area in which it is to be sold. If this value is set incorrectly, the tunes in frequency may be wrong, or sound may be distorted, resulting in an inability to reproduce reception signals at their proper sound quality. For this reason, be sure to confirm that the values are set correctly before first using the unit.

### FM 100 kHz, AM 10 kHz:

Set to this position, for areas with an FM reception step of 100 kHz and AM 10 kHz.

### FM 50 kHz, AM 9 kHz:

Set to this position, for areas with an FM reception step of 50 kHz and AM 9 kHz.

### NOTE:

When unsure about the channel allocation for your area, consult your dealer for correct information.

### To Change Channel Steps

With the power turned OFF, hold the ⏻ STANDBY/ON button depressed while pressing the BAND button to turn the power ON.

- Each time the above operation is performed, the channel tuning step will alternate between FM 100 kHz/AM 10 kHz, and FM 50 kHz/AM 9 kHz.

⏻ STANDBY/ON

BAND

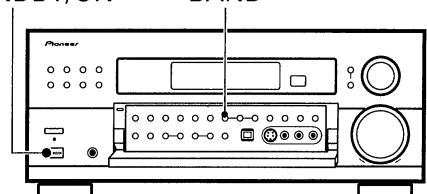

## Setting Up for Surround Sound

To ensure the best possible surround sound, complete the following setup operations. You only need to make these settings once (unless you change the placement of your current speaker system or add new speakers, etc.). To set up the VSX-D859TX/D859TXG's home cinema system use on-screen displays on your TV or the front panel display on the receiver. Switch on the receiver and your TV, and make sure that the receiver is selected as your TV's video input. You can also use the front panel display on the receiver. These instructions are written using the remote control to make the settings but you can also use the MULTI JOG dial, SETUP and RETURN buttons on the front panel. Turn the MULTI JOG dial left or right to instead of using the ▲ or ▼ arrow buttons and press the MULTI JOG dial to enter the command.

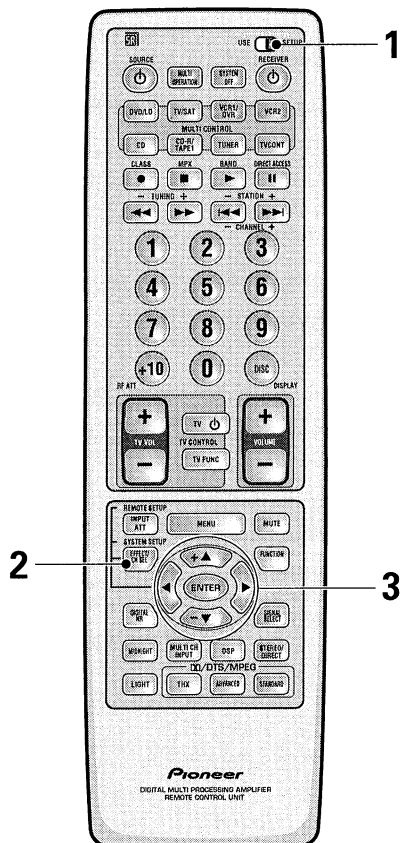

### 1 Set the slide switch on the remote control to SETUP.

Also make sure your TV is on and set to the receiver.

- When you're done setting up the receiver, remember to set the slide switch back to USE.

### 2 Press the SYSTEM SETUP button on the remote control.

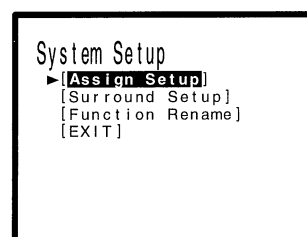

This SYSTEM SETUP MENU appears on your TV screen, though it is also useful to look at the display on the receiver as well as your TV.

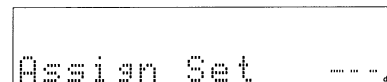

- You can escape from this screen at any time by pressing the SYSTEM SETUP button again. None of the settings you made will be entered in this case.
- If don't enter any settings the receiver will revert back to its previous state after three minutes.
- If you want to go back one level in the setup process press the RETURN button on the front panel.

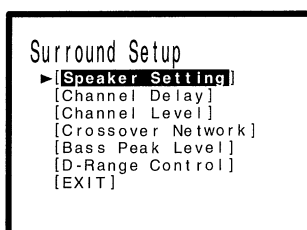
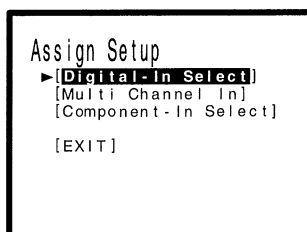

Function	Rename
▶ DVD/LD	[ DVD/LD ]
VCR2	[ VCR2 ]
VCR1	[ VCR1/DVR ]
VIDEO	[ VIDEO ]
PHONO	[ PHONO ]
CD-R	[ CD-R/TAPE1 ]
CD	[ CD ]
TV/SAT	[ TV/SAT ]
[EXIT]	

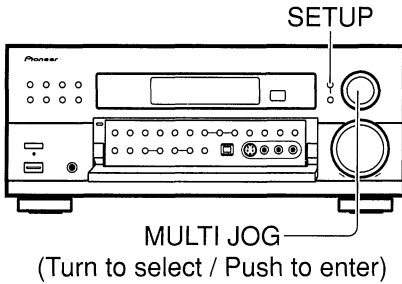

### 3 Press the ▲ or ▼ arrow buttons (or turn the MULTI JOG dial) to move the hand to the second tier of setup modes and choose the one you want. Then press the ENTER button (or the MULTI JOG dial).

There are three second tier setup modes: **ASSIGN SETUP**, **SURROUND SETUP** and **FUNCTION RENAME**. The first of these, ASSIGN SETUP, is for telling the receiver which components are hooked up to which terminals and how they are connected. In the ASSIGN SETUP menu you must make the DIGITAL-IN-SELECT adjustments if you didn't follow the default settings when you hooked up your DVD/LD player.

We suggest you start with DIGITAL-IN-SELECT and adjust and make all the necessary adjustments here and then move on to the other entries in this menu and decide if you need to make these adjustments. It is likely you will not need to bother with any of the other things on this menu.

Next move on to the SURROUND SETUP menu and make all the necessary settings. It is essential you make these settings in order to get good surround sound.

The last set up menu, FUNCTION RENAME, lets you customize the receiver to match your home system. This is not an essential setting to make.

The system set up modes are explained on the next page in a little more detail. The order follows that of the SYSTEM SETUP menu.



After you complete one of the SYSTEM SETUP menus and return to the basic SYSTEM SETUP screen the receiver automatically moves the cursor to the next SYSTEM SETUP menu. For example, if you've completed SPEAKER SETTINGS and returned to the basic SYSTEM SETUP screen, CHANNEL DELAY will be selected automatically. You can notice this on your TV screen or your front panel display.

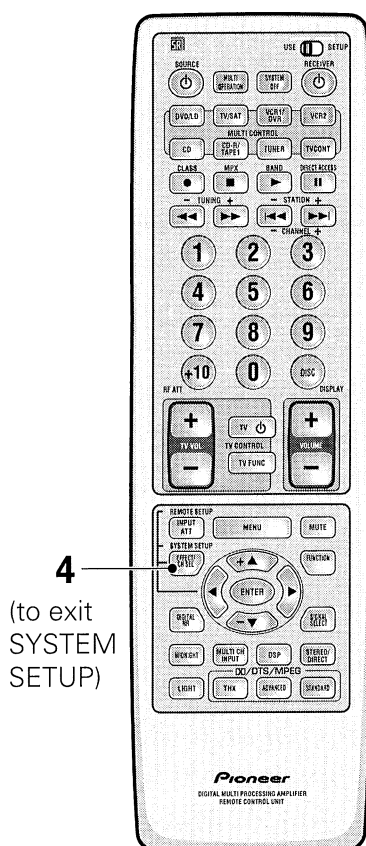

## ASSIGN SETUP:

### Digital In Select (See p. 30)

In order to use your digital components you must match the numbered digital input settings with the numbered digital jacks used by your digital components.

### Multi Channel In (See p. 31)

This is for hooking up a multi channel external decoder that may give you higher quality when decoding discs. This feature lets you select adjustable to non-adjustable sound.

### Component-In Select (See p. 32)

In order to use component video connections you must tell the receiver which components are hooked to which terminals.

## SURROUND SETUP:

### Speaker Setting (See p. 33 – 34)

Use to specify the type and number of speakers you connected.

### Channel Delay (See p. 35)

Adding a slight delay to some speakers enhances sound separation and is particularly important for achieving a surround sound effect. You need to figure out the distance from your listening position to your speakers to add the proper delay.

### Channel Level (See p. 36 – 37)

Use to balance the volumes of your different speakers.

### Crossover Network (See p. 38)

This feature lets you select which bass frequencies will be sent to the subwoofer or front speakers.

### Bass Peak Level (See p. 39)

Dolby Digital, DTS and MPEG audio sources include ultra-low bass tones. Set the bass peak level as needed to prevent the ultra-low bass tones from distorting the sound from the speakers.

### D-Range Control (See p. 40)

This feature makes possible excellent surround sound effects when listening to Dolby Digital sources at low volumes.

## FUNCTION RENAME (See p. 73 – 74)

This feature lets you rename specific "functions," which in this case stands for components like DVD/LD, VCR 1/DVR, etc. This is a useful feature for matching the remote control and receiver display exactly with your home setup.

## 4 Go on to the next page to start the set up.

If you don't want to make any settings go can exit this setup. To exit the SYSTEM SETUP MENU and on-screen display press SYSTEM SETUP button again.

**ASSIGN SETUP MENU**

**Digital-In Select**

In order to be able to use your digital equipment properly you need to assign digital inputs for each of the digital components you connected. Match the Digital 1 – 4 settings with the digital jacks 1 – 4 in accordance with what is connected to each digital jack. Check the digital jack numbers on the back of the receiver to make certain what component is in which jack (if necessary, see page 12 for more on digital connections). If continuing from the last page go to step 1. If starting fresh, complete steps 1 – 3 in "Setting Up for Surround Sound" (p. 27– 28) first.

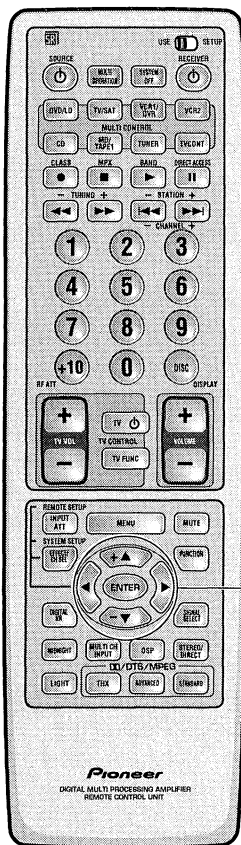

1-4

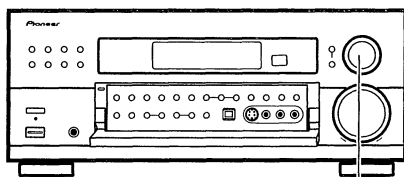

**MULTI JOG**  
(Turn to select / Push to enter)



The default settings for the DIGITAL INs are printed next to the digital jacks in parentheses on the back of the receiver.

The optical jack on the front panel is set to the VIDEO input on the MULTI JOG dial. It can't be assigned.

**1 "Digital In" should be selected (if it isn't use the ▲/▼ buttons, or the MULTI JOG dial, to select it).**

See "Setting Up for Surround Sound" on p. 27– 28) if you need more information.

**Press the ENTER button.**

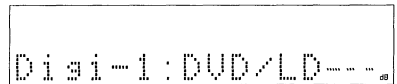
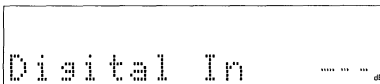
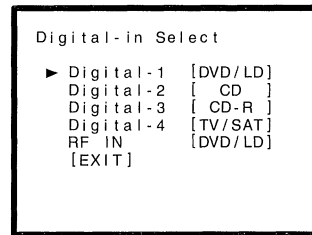
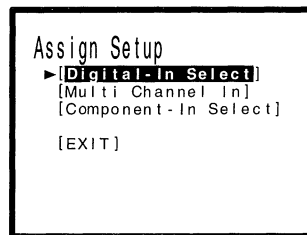

**2 The "Digital-1" ("Digi-1" on the front panel) should be selected. To change the digital input press ENTER and it will start to flash on the receiver's display.**

If you want leave it as is, use the ▲/▼ buttons to move on to DIGITAL IN 2 and then the other Digital In settings.



**3 Use the ▲/▼ buttons (or the MULTI JOG dial) to choose the input function that matches the component hooked up to that digital terminal. Press ENTER when you've matched the two.**

The possible choices include: DVD/LD, TV/SAT, CD, CD-R/TAPE 1/MD, VCR 1/DVR, VCR 2. You cannot assign digital inputs to the TUNER, VIDEO and TAPE 2 MONITOR functions.

If you assign a function (for example DVD/LD) that was previously assigned to a different Digital In the first Digital In will automatically revert to an OFF setting. This is because one function cannot be assigned twice.

Pressing ENTER moves you to the next DIGITAL IN. Repeat steps 2 & 3 until all the Digital Ins are set.

**4 When you've finished assigning digital ins select EXIT ("Dig-In End" on the front panel) with the ▲/▼ buttons (or the MULTI JOG dial) and press ENTER to go to "Multi In Set".**

If you want to change a setting before proceeding simply use the arrow buttons to go back.

## Multi Channel In setting

For most people this setting will not be necessary, if this is the case for you go on to the next setup. If you have a Multi Channel external decoder you can choose whether to have the sound level set to BYPASS, which bypasses the level adjust circuit or set to ADJUST, which goes through the level adjust circuit. If continuing from "Digital In Select" go to step 1. If starting fresh, complete steps 1 – 3 in "Setting Up for Surround Sound" (p.27–28) first.

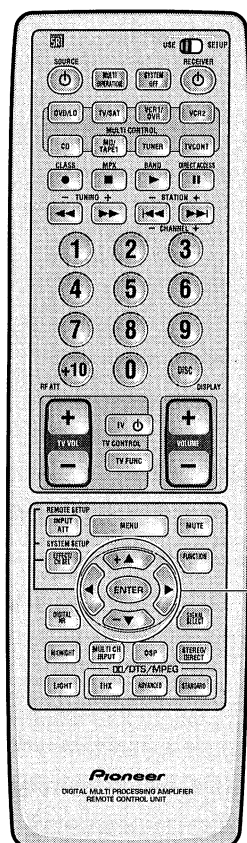

### 1 "Multi Channel In" ("Multi In Set" on the front panel) should be selected (if it isn't use the ▲/▼ buttons, or the MULTI JOG dial, to select it).

See "Setting Up for Surround Sound" on p. 27– 28) if you need more information.

Press the **ENTER** button. This information will be displayed.

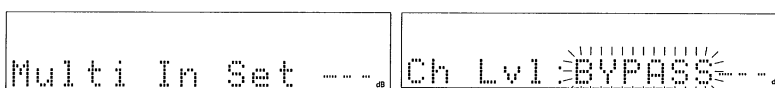
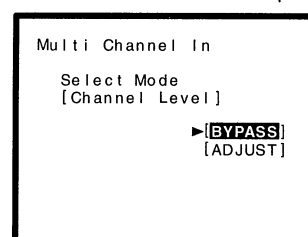
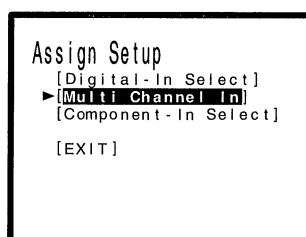

### 2 Use the ▲/▼ buttons (or the MULTI JOG dial) to select the setting you want, BYPASS or ADJUST.

**ADJUST:** Use the ADJUST setting when you want to be able to control each channel level individually.

**BYPASS:** This setting is good for getting the cleanest possible signal. In this setting you won't be able to change each channel individually.

We recommend using BYPASS and the default setting is BYPASS.

### 3 Press the **ENTER** button.

You will go to "Assign End".

### 4 Press **ENTER** again and move on to "Component In Select" setting.

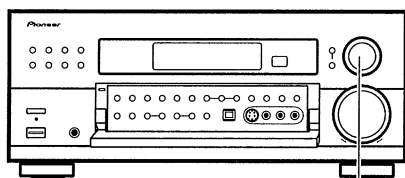

MULTI JOG  
(Turn to select / Push to enter)

## Initial Set up

### Component In Select setting

For most people this setting will not be necessary, if this is the case for you go on to the next setup. If you hooked up equipment with component video you need to assign the terminals for the devices you connected.

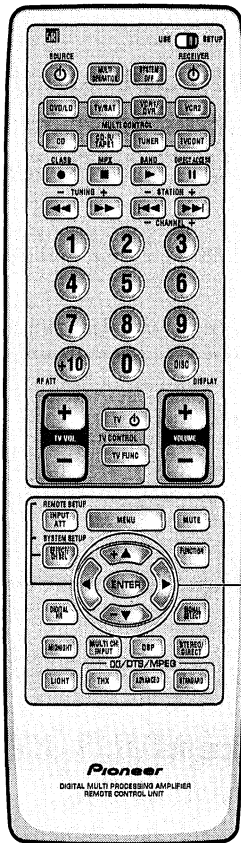

- 1 Select "Component In Select" using the ▲/▼ buttons (if continuing from the last set up, it should already be selected).

See "Setting Up for Surround Sound" on p. 27–28 if you need more information.

Press the ENTER button.

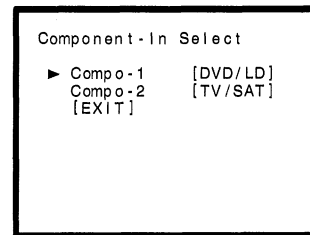
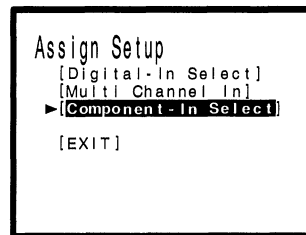

- 2 Choose "Compo 1" or "Compo 2" using the ▲/▼ buttons. To change the component video function press ENTER and the function will start to flash on the receiver's display.

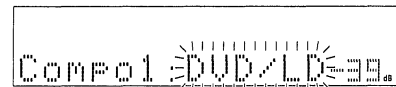

- 3 Use the ▲/▼ buttons to choose the input function that matches the component hooked up to that terminal. Press ENTER when you've matched the two. The receiver will enter the information and automatically go on to the next setting.

The possible choices include: DVD/LD, TV/SAT, VCR 1, VCR 2. You cannot assign digital inputs to the TUNER, VIDEO, CD, PHONO, VIDEO, CD-R/TAPE 1/MD, and TAPE 2 MONITOR functions.

If you assign a function (for example DVD/LD) that was previously assigned to a different Component In the second Component In will automatically revert to an OFF setting. This is because one function cannot be assigned twice.

- 4 When you've finished assigning component ins select EXIT ("Comp In End" on the front panel), if not already selected. Press ENTER to move to the "Surround Set" set up.

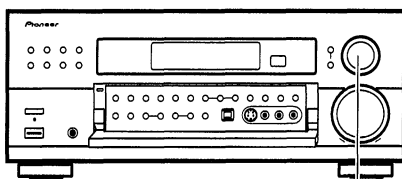

(Turn to select / Push to enter)

If you want to change a setting before proceeding simply use the arrow buttons (or MULTI JOG dial) to go back.



## SURROUND SETUP MENU

## Speaker Setting

Starting from this procedure use the SURROUND SETUP menu. To access the menu follow steps 1 – 3 on p.27– 28 and in step three choose SURROUND SETUP (Surround Set is shown on the receiver's display). The steps below show you how to specify the type of speakers you connected. Use the ▲/▼ buttons (or the MULTI JOG dial) to make a selection from the on-screen menus, and use the ENTER button to register the information.

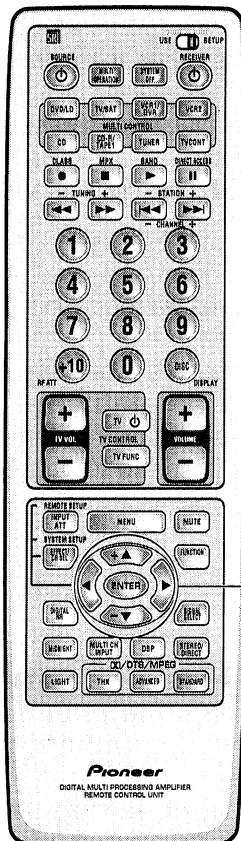

1-4

### 1 "Speaker Setting" ("Speaker Set" on the front panel) appears in the display. Press ENTER button.

See "Setting Up for Surround Sound" on p. 27– 28 if you are unsure how to get to the "Speaker Setting" menu.

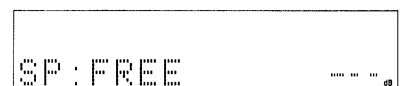
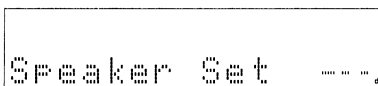
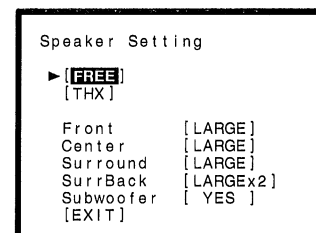
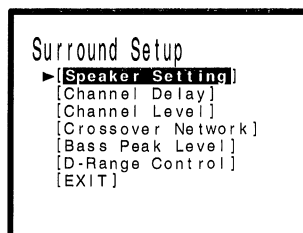

### 2 Select either the FREE or THX speaker setting mode with the ▲/▼ buttons then press ENTER.

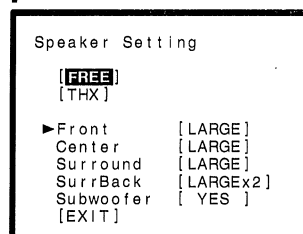

To specify each speaker individually select FREE.

If you connected a complete set of THX speakers select THX and skip the SURROUND BACK part of step 3.

### 3 Specify the type of speakers you connected. See the explanations below for the meaning of each size.

- ① Press ENTER. Use the ▲ or ▼ buttons (or MULTI JOG dial) to move the cursor to the speaker you want to adjust.
- ② Press ENTER to select that speaker. The speaker name will flash in the receiver's display.
- ③ Press ▲ or ▼ to move the setting to LARGE, SMALL, or NO depending on the size of your speakers (you can't select NO for the FRONT speakers and the SURROUND BACK speakers have a few more settings). See the next page for detailed explanations.
- ④ Repeat ② – ④ for each speaker.

Depending on your choices the sound will be routed differently, read below for detailed explanations.

#### FRONT (default setting is LARGE)

- Select SMALL to send bass frequencies to the subwoofer.

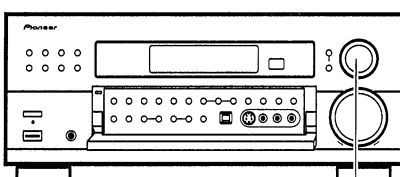

MULTI JOG  
(Turn to select / Push to enter)

- Select LARGE if your speakers will reproduce bass frequencies effectively or if you did not connect a subwoofer.  
(If you select SMALL for the front speakers the subwoofer will automatically be set to YES. Also, the center and surround speakers cannot be set to LARGE if the front speakers are set to SMALL. In this case, all bass frequencies are sent to the subwoofer.)

### **CENTER (default setting is LARGE)**

- Select LARGE if your speaker will reproduce bass frequencies effectively.
- Select SMALL to send bass frequencies to the other speakers or the subwoofer.
- If you did not connect a center speaker select NO. In this case, the center channel is output from the front speakers.
- If the front speakers are set to SMALL the CENTER speaker will automatically be set to SMALL.

### **SURROUND (default setting is LARGE)**

- Select LARGE if your speakers will reproduce bass frequencies effectively.
- Select SMALL to send bass frequencies to the other speakers or the subwoofer.
- If you did not connect SURROUND speakers select NO. In this case, the sound of the surround channels is output from the front and center speakers.
- If the FRONT speakers are set to SMALL, the SURROUND speakers will automatically be set to SMALL.

### **SUBWOOFER (default setting is YES)**

- Select YES if you connected a subwoofer.
- If you did not connect a subwoofer select NO. In this case, the bass frequencies are output from the front or surround speakers.
- Choose the PLUS setting if you want stronger reproduction of deep bass sounds.
- If you select PLUS the bass frequencies that would normally come out the front and center speakers are all routed to the subwoofer.

### **SURROUND BACK (default setting is LARGE X2)**

**NOTE: In order to use SURROUND BACK speakers you need to hook them up through an external amplifier (see p. 18 & 20 for more on this).**

- Select the number of SURROUND BACK speakers you have. You can choose one speaker, two or none. The one speaker setting will just be shown as just the size (for example, SMALL) while the two speaker setting will be shown as X2.
- If the FRONT speakers or the SURROUND speakers are set to SMALL, the SURROUND BACK speakers will automatically be set to SMALL.
- Select LARGE if your speakers will reproduce bass frequencies effectively.
- Select SMALL to send bass frequencies to the other speakers or subwoofer.
- If you did not connect surround back speakers select NO. In this case no sound will be output to the SURROUND BACK CHANNELS.
- If you choose THX in step 2 then the SURROUND BACK speakers can only be set to SMALL (or NO).



If you have a subwoofer and like lots of bass, it may seem logical to select LARGE for your FRONT speakers and leave the subwoofer selected. This may not, however, yield the best bass results.

Depending on the size and shape of your room you may actually experience a decrease in the amount of bass due to what is called "low frequency cancellations." If you have a subwoofer, listen to the bass response with the FRONT speakers set to LARGE and SMALL alternatively and let your ears judge which sounds best.

The safest option in this case is to route all the bass sounds to the subwoofer by selecting SMALL for the FRONT speakers.

## **4 Select EXIT ("Sp Set End" on the front panel) with the ▲/▼ buttons and press ENTER to go to the "Channel Delay" setup.**

Next, proceed to "Channel Delay" on the next page.

**If you want to change a setting before proceeding** use the arrow buttons (or MULTI JOG dial) to go back.

## Channel Delay

Adding a slight delay to some speakers is necessary to achieve a surround sound effect. You need to figure out the distance from your listening position to your speakers to add the proper delay. The following steps show you how to set the delay time for each channel by specifying the distances from your listening position to each speaker. Once you specify the speaker distances, the receiver calculates the correct delay times automatically. If continuing from "Speaker Setting" go to step 1. If starting fresh, complete steps 1 – 3 in "Setting Up for Surround Sound" (p. 27– 28) first.

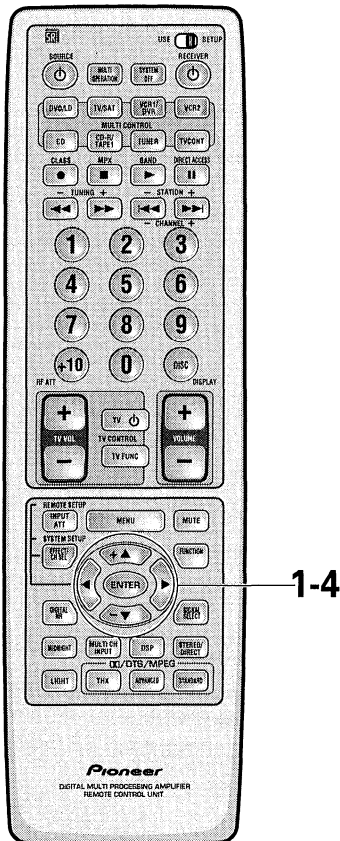

### 1 Select "Channel Delay" with the ▲/▼ buttons or MULTI JOG dial (if continuing from the last set up, it should already be selected).

See "Setting Up for Surround Sound" on p. 27– 28 if you are unsure how to do this.

Press the ENTER button.

- The default setting is 2 m.

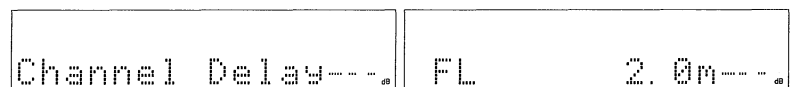
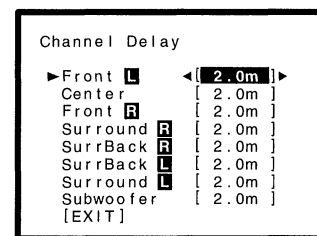
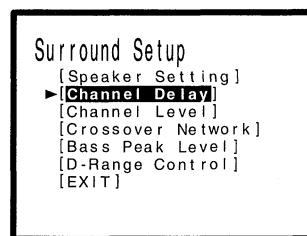

### 2 Press ENTER.

The distance of the first speaker will flash in the receiver's display

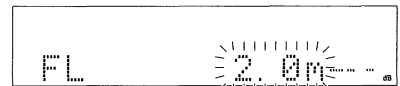

### 3 Specify the distance from your listening position to each speaker using the commands below.

- ① Use the ▲/▼ buttons to adjust the speaker distance in 0.1 meter increments from 0.1 to 9 meters.  
The default setting is 2 m.
- ② Press ENTER.
- ③ Repeat steps 2 and 3 for the rest of the speaker settings.

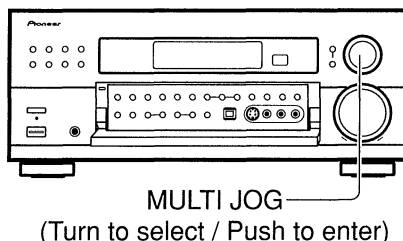

### 4 When you've finished the last setup and pressed ENTER, EXIT ("Ch Delay End" on the front panel) should be selected. Press ENTER button again to send the information to the receiver and go to the "Channel Level" setup.

If you want to change a setting before proceeding use the arrow buttons (or MULTI JOG dial) to go back.

SET UP

## Channel Level

The following steps show you how to balance the sound output level of your speakers. Proper speaker balance is essential for obtaining high quality surround sound. If continuing from "Channel Delay" go to step 1. If starting fresh, complete steps 1 – 3 in "Setting Up for Surround Sound" (p 27– 28) first.

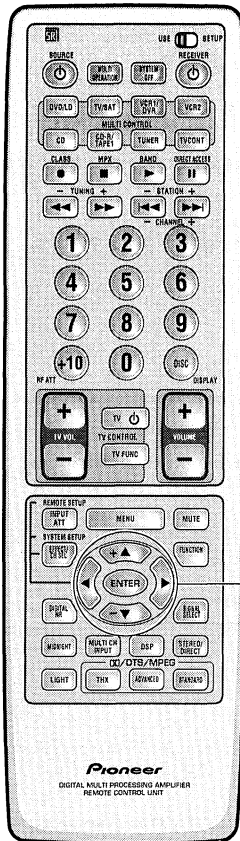

### 1 Select "Channel Level" (if continuing from "Channel Delay", it will already be selected).

See "Setting Up for Surround Sound" on p. 27– 28 if you are unsure how to do this.

Press the ENTER button.

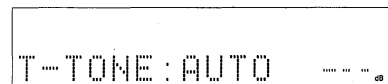
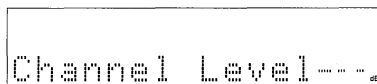
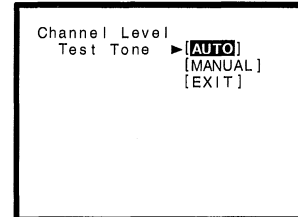
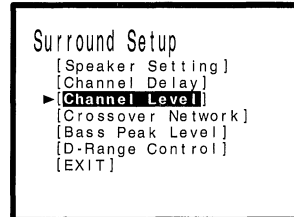

### 2 Select a TEST TONE mode.

- ① Press ▲/▼ to move the cursor to AUTO or MANUAL.
- ② Press ENTER to start the test tone.

#### AUTO (automatic TEST TONE)

This mode switches the test tone between each speaker automatically.

The test tone is output in the following order

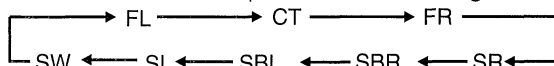

#### MANUAL (manual TEST TONE)

This mode lets you switch the test tone between each speaker manually. You can use this mode when you want to balance the speaker levels by ear at a more leisurely pace.

The test tone is output in the following order

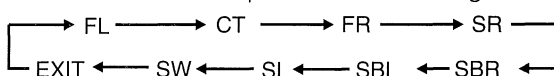

### 3 After pressing ENTER it will take a moment for the volume to get to the reference position (0 dB) and the TEST TONE will be output.

These settings will be displayed on your TV.

AUTO

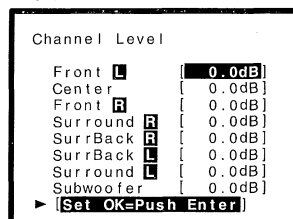

MANUAL

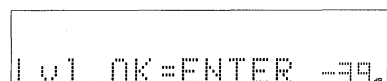
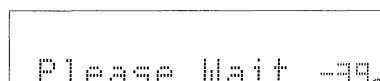
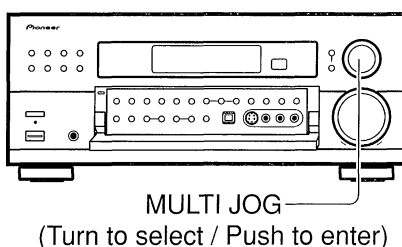
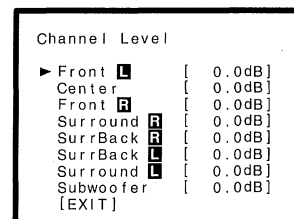

(This display appears when you choose Auto test mode.)

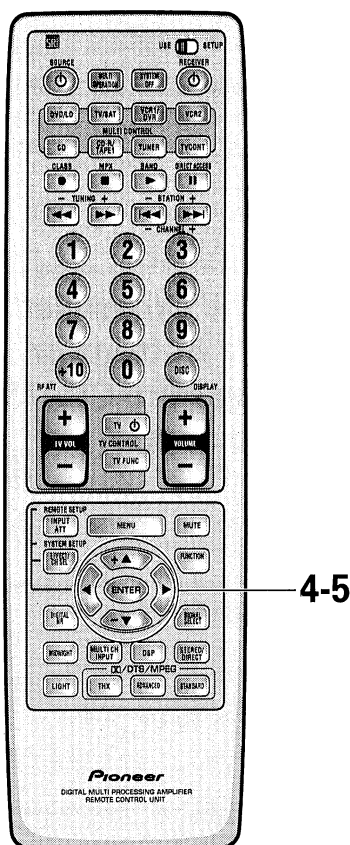

#### 4 Adjust speaker levels so that you hear the test tone at the same volume from each speaker when seated in your main listening position.

Note: The volume of the subwoofer tends to sound lower than it actually is, you may need to raise its level after testing the sound with actual soundtracks.

##### In AUTO mode

The receiver will automatically cycle through the speakers emitting a test tone from each one. It will continue to do this until you press ENTER to signify you have finished your adjustments. It will again take a moment as the MASTER VOLUME returns to its original position.

##### In MANUAL mode

- ① Press ENTER
- ② Press the ▲/▼ buttons to adjust the level of the speaker outputting the TEST TONE.
- ③ Press ENTER again to input the information and move to the next channel.
- ④ Repeat ①, ② and ③ for each speaker.
- ⑤ When you're finished select EXIT. it will again take a moment as the MASTER VOLUME returns to its original position.

##### If you are using a Sound Pressure Level (SPL) meter

Take the readings from your main listening position and adjust the level of each speaker to 75 dB SPL (C-weighted/slow mode).

#### 5 Press ENTER to go to the "Crossover Network" setup menu.

If you want to change a setting before proceeding use the ▲/▼ buttons (or MULTI JOG dial) to go back.



When sounding the TEST TONE for the SURROUND BACK speakers you must use the external amplifier you hooked up with your SURROUND BACK (see p. 4, 18 & 20, 33-34) so the amplifier must be on and have the volume turned up.

It is possible to set channels levels independently for **DD**/dts/MPEG, STEREO, MULTI CHANNEL IN and each DSP mode for listening-once purposes (see p. 44) but if you do so these levels will remain in **DD** Surround/dts setup mode unless put back to zero. They will show up the display in step 3.

Note that it is also possible to set channel levels temporarily. Then follow the same procedure as explained on this page. This function is designed to be used when you want to change the levels temporarily to raise the level of one channel. Using this method you can set speaker levels in different modes, such as, STEREO, and each DSP mode, independently. You should return the settings to their original state when done. Doing the set up procedures on this page will erase any temporary/independent level settings that have been made.

(This display appears when you choose Auto test mode.)

## Crossover Network

If you're using small speakers that can't reproduce good bass, you should have set those speakers to SMALL in the Speaker Setting section. This causes the bass to be routed to other speakers in your system which can handle it either the subwoofer or speakers set to LARGE in Speaker Setting. The Crossover Network setting lets you specify a frequency, below which, sound will be routed to these other speakers.

If continuing from "Channel Level" go to step 1. If starting fresh, complete steps 1 – 3 in "Setting Up for Surround Sound" (p. 27– 28) first.

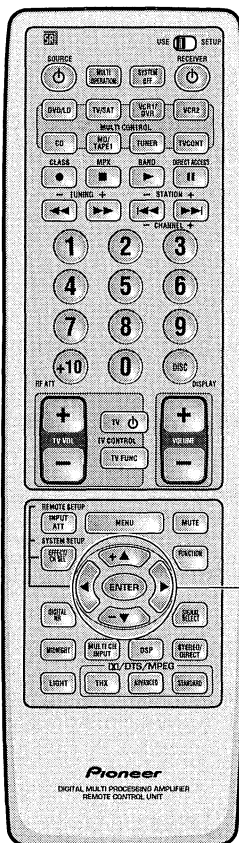

1-3

### 1 Select "Crossover Network" ("Crossover" on the front panel) with the ▲/▼ buttons or MULTI JOG dial (if continuing from CHANNEL LEVEL, it will already be selected).

See "Setting Up for Surround Sound" on p. 27– 28 if you are unsure how to do this.

Press the ENTER button.

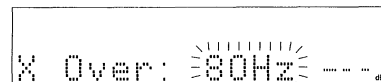
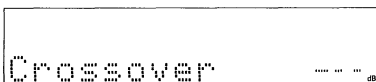
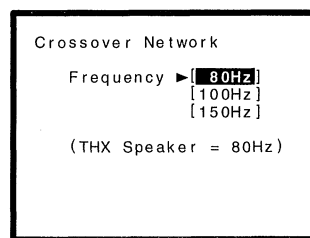
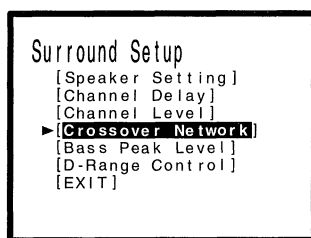

- The default setting is 80 Hz.

### 2 Specify the crossover frequency for your small speakers.

Setting speakers to SMALL in "Speaker Setting" sends the respective channel's bass frequencies to the subwoofer (or LARGE speakers if you don't have a subwoofer). The present function lets you determine which frequencies will be sent to the subwoofer (or LARGE speakers).

- ① Use the ▲/▼ buttons to select 80 Hz, 100 Hz, or 150 Hz.

#### 80 Hz (default/THX setting)

Sends bass frequencies below 80 Hz to the subwoofer (or LARGE speakers).

#### 100 Hz

Sends bass frequencies below 100 Hz to the subwoofer (or LARGE speakers).

#### 150 Hz

Sends bass frequencies below 150 Hz to the subwoofer (or LARGE speakers).

Experiment with the different settings to see which sounds best to you.

### 3 Press ENTER to send the information to the receiver and go to the "Bass Peak Level" setup.

If you want to change a setting before proceeding use the ▲/▼ buttons (or MULTI JOG dial) to go back.

## Bass Peak Level

The LFE (Low Frequency Effect) channel in Dolby Digital, DTS or MPEG program sources can produce heavy ultra-low bass tones that may exceed the capabilities of your speaker system. The following steps show you how to set a maximum output level for the LFE channel. If continuing from "Crossover Network" go to step 1. If starting fresh, complete steps 1 – 3 in "Setting Up for Surround Sound" (p. 27– 28) first.

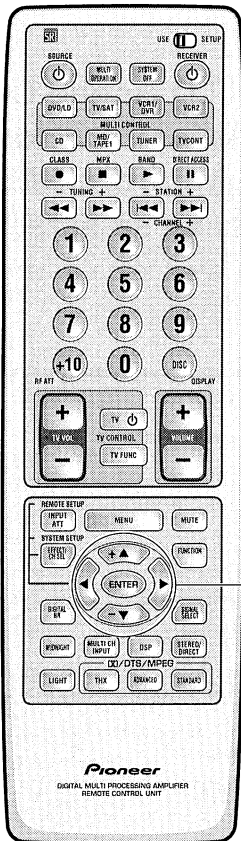

1-3

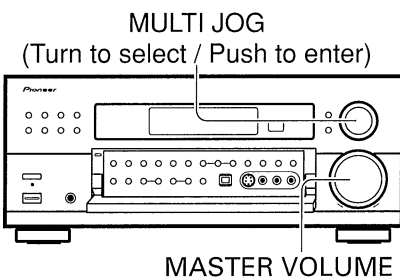

### 1 Select "Bass Peak Level" ("Bass Level" on the front Panel) with the ▲/▼ buttons or MULTI JOG dial (if continuing from CROSSOVER NETWORK it will already be selected).

See "Setting Up for Surround Sound" on p. 27– 28 if you are unsure how to do this.

Press the ENTER button.

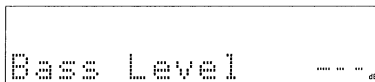
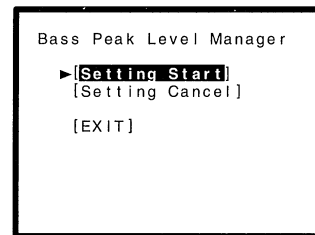
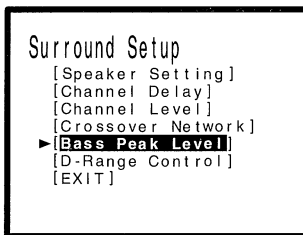

### 2 Output the test tone for the LFE channel and specify the peak level.

If your subwoofer has a volume control, set it to the middle position before proceeding.

① SETTING START will be selected, press ENTER

The MASTER VOLUME goes to the reference level [MIN (–dB)]. Then the test tone is output to the subwoofer, front or surround speakers.

② Use the ▲/▼ buttons (or the MULTI JOG dial) to select the BASS PEAK LEVEL. Each press moves the level 1dB in a range of -80dB to +12dB. Gradually increase the level of the LFE channel until the test tone begins to distort. Then go back and leave the level setting at a point just before that.

③ Press the ENTER button.

It takes a few seconds for the MASTER VOLUME to return to its previous position.

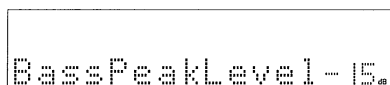
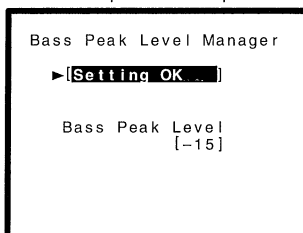

### 3 EXIT ("Bass Peak Level End" on the front panel) should be selected, press the ENTER button to go to the "D-Range Control" setup.

Next, proceed to "Dynamic Range Control" on the next page.

If you want to change a setting before proceeding use the ▲/▼ buttons (or the MULTI JOG dial) to go back.

## Dynamic Range Control

This feature makes it possible to enjoy full surround sound effects on Dolby Digital sources even at low volumes. It does this by compressing the dynamic range. Dynamic range is the difference between the loudest and the softest sounds in any given soundtrack. Compressing the range plays sounds so the quieter ones are audible and the louder ones don't get distorted or become overpowering. This feature only applies to Dolby Digital sources but the MIDNIGHT LISTENING mode accomplishes the same end for a variety of sources (see page 49). If continuing from "Bass Peak Level" go to step 1. If starting fresh, complete steps 1 – 3 in "Setting Up for Surround Sound" (p. 27– 28) first.

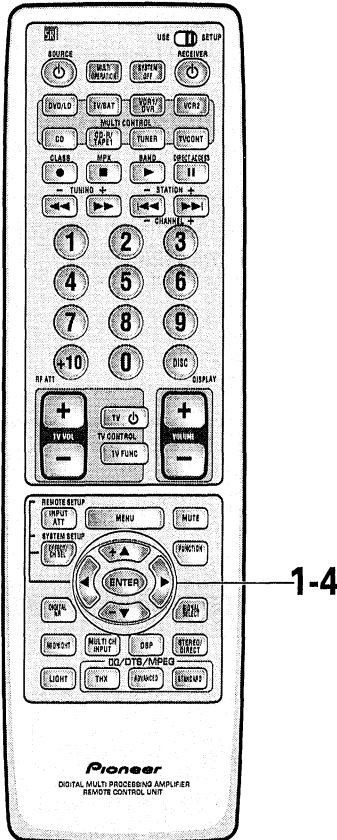

### 1 Select "D-Range Control" ("D-Range Cont" on the front panel) with the ▲/▼ buttons or MULTI JOG dial (if continuing from BASS PEAK LEVEL, it will already be selected).

See "Setting Up for Surround Sound" on p. 27– 28 if you are unsure how to do this.

Press the ENTER button.

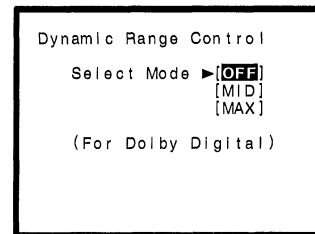
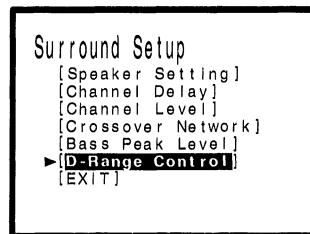

- The default setting is OFF.
- If listening at loud volumes we recommend turning the Dynamic Range Control OFF.

### 2 Use the ▲/▼ buttons to choose OFF, MID or MAX.

### 3 Press the ENTER button.

If you want to change a setting before proceeding

Choose a new Dynamic Range Control setting using the ▲/▼ buttons (or the MULTI JOG dial).

You may need to experiment with different Dolby Digital sources before you can use the Dynamic Range Control setting to suit your low volume listening needs.

### 4 "Surr Set End" will appear in the display. Press the ENTER button.

You will go on to the "Rename" tier of the setup menus. This is not necessary for the basic operation of the receiver but lets you customize your system (see p. 73). If you don't want to rename anything at this time use the ▲/▼ buttons (or the MULTI JOG dial) to select "Setup End" and press ENTER.

This setting completes the surround setup.

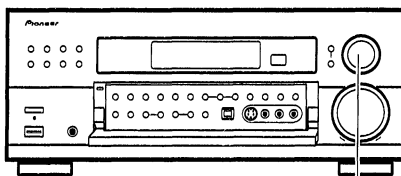

MULTI JOG  
(Turn to select / Push to enter)



# Basic Playback

## Sound Modes

The five sound modes on the receiver are explained here. These can be turned on from the front panel or from the remote control.

There are three cinema modes: STANDARD, HOME THX CINEMA, and ADVANCED THEATER. These are designed to be used with multi channel surround sound audio/visual sources (like DVDs and LDs). Intrinsic to home theater, these modes can deliver realistic and powerful surround sound that recreates the movie theater experience. You may need to experiment with them to see which settings suit your home system and personal tastes.

The DSP and STEREO modes are designed to be used with music sources but some DSP modes are also suited for film soundtracks. Again, try different settings with various soundtracks to see which you like.

You must choose one of the three cinema modes or the DSP mode in order to get surround sound. In STEREO mode only the front two speakers, and sometimes the subwoofer (if you have one), are used.

### STANDARD modes

This mode is for pure decoding of Dolby Digital, Dolby Pro Logic, DTS and MPEG sources. No special effects are added. It is good for enjoying regular movies/videos that have been recorded in Dolby Digital, Dolby Pro Logic, DTS and MPEG. STANDARD 7.1 is also the basic mode for enjoying sources with SURROUND BACK channels. For more detailed information see p. 82– 84. You will only be able to access the second two modes if you have hooked up SURROUND BACK speaker(s). For more detailed information see p. 4, 18, 20, 33– 34. The display will show you what kind of source (Dolby Digital, DTS, etc.) is being played.

#### STANDARD

Use this mode with sources that do not have SURROUND BACK channels. If you don't have SURROUND BACK speaker(s) switched on (see p. 33– 34) this is the only STANDARD mode you will be able to select on the receiver.

#### STANDARD 7.1

This mode is best for sources with SURROUND BACK channels. You will only be able to access this mode if you have set the SURROUND BACK speakers in the SPEAKER SETTING procedure (see p. 33– 34). Also, this mode will play 5.1 channels sources and other sources through all the speakers you have hooked up, routing some of the sound into your SURROUND BACK channel or channels. STANDARD 7.1 will appear in the display even if you only have one SURROUND BACK speaker hooked up. The display will change according to the source played.

#### STANDARD AUTO

In this mode the receiver will automatically select the appropriate STANDARD mode and use it to play the soundtrack. You will only be able to access this mode if you have set the SURROUND BACK speaker(s) in the "Speaker Setting" procedure (see p. 33– 34). If the source has a SURROUND EX marker then the receiver will automatically go into STANDARD 7.1 mode. This mode is best if you are unsure which of the above STANDARD modes to use. The display will change according to the source played.

## Basic Playback

### HOME THX CINEMA modes

THX is a set of technical standards created by Lucasfilm, Ltd. These standards were designed to emulate a film sound stage and thus reproduce, with the greatest possible accuracy, the soundtrack intended by the filmmakers. To get THX sound use one of the three modes explained below. You will only be able to access the second two modes if you have hooked up SURROUND BACK speakers. For more detailed information see p. 4, 18, 20, 33– 34. This mode is best if you are unsure which of the above THX modes to use. The display will show you what kind of source (Dolby Digital, DTS, etc.) is being played.

#### THX CINEMA

Use this mode to get THX sound with sources that do not have SURROUND BACK channels. If you don't have SURROUND BACK speaker(s) switched on (see p. 33– 34), this is the only THX mode you will be able to select on the receiver.

#### THX SURROUND EX

This mode is specifically for using your SURROUND BACK channels with either SURROUND EX sources or 5.1 channel sources. You will only be able to access this mode if you have set the SURROUND BACK speaker(s) in the SPEAKER SETTING procedure (see p. 33– 34). If the source you are using is a 5.1 source then this mode will route some of the sound to the SURROUND BACK channel(s). If the source you are using does not have a SURROUND EX marker or is not a 5.1 source then the display will automatically change to THX CINEMA.

#### THX AUTO

In this mode the receiver will automatically select the appropriate THX mode and use it to play the soundtrack. You will only be able to access this mode if you have set the SURROUND BACK speaker(s) in the SPEAKER SETTING procedure (see p. 33– 34). If the source has a SURROUND EX marker then the receiver will automatically go into THX SURROUND EX mode. This mode is best if you are unsure which of the above THX modes to use.

### ADVANCED THEATER modes

The Advanced Theater mode is a newly designed system for enhancing movie soundtracks and other audio-visual sources. It incorporates the use of DTS, Dolby Digital as well as MPEG into its sound processing. These functions switch on automatically when the source you are playing is encoded with DTS, Dolby Digital or MPEG. There are four Advanced Theater settings that use DSP (Digital Signal Processing) to create different types of sound environments. If you have SURROUND BACK speakers or (even just one) speaker switched on (see p.33– 34) then 7.1 will appear after the name of all of these modes in the display on the receiver. The display will show you what kind of source (Dolby Digital, DTS, etc.) is being played.

#### MUSICAL

This mode is primarily for music and adds a spacious feeling to the sound. A long delay time of reflected sounds, provides resonant tones which emulate a concert hall.

#### DRAMA

This mode is designed for movies with a lot of dialog. The elements of dialog are enhanced, making the characters seem more real. The mode also compresses the dynamic range somewhat so loud sounds do not overpower softer ones (compare this with the MIDNIGHT LISTENING mode explained on p. 49).

#### ACTION

This mode is designed for action movies, which generally use lots of sound effects. The mode enriches the sound to make it more realistic and extends the parameters to pick up high and low sound effects.

#### 5/7-D THEATER

This mode is especially designed to give sound depth to stereo sources. The overall effect builds a dynamic and broad sound space, allowing two-channel (stereo) signals to faithfully imitate a five speaker sound. The mode should be used in conjunction with Dolby Pro Logic for sources bearing the

 **DOLBY SURROUND** mark.



When a Dolby Digital soundtrack is played back the Dialog Normalization function of the receiver activates automatically. Dialog Normalization is a Dolby Digital function that establishes the average dialog level for the program source being played. If the receiver's level does not match the average dialog level, first you see "DIAL NORM" flash in the receiver's display and next "OFFSET +4 dB" (as an example) will appear. In this example, the number +4 dB is the difference between the receiver's gain structure and the Dolby Digital average dialog level. To match the average dialog level, subtract or add the OFFSET level. For example, if the OFFSET level is +4 dB, the amplifier's output is 4 dB over the average recorded level.

## DSP modes

The DSP (Digital Signal Processing) modes allow you to transform your living room into a variety of different sonic environments when playing either two-channel or multi-channel sources. If you have SURROUND BACK speaker(s) switched on (see p. 33– 34) then 7.1 will appear after the name of all of these modes in the display on the receiver.

### HALL 1

Simulates the acoustic effects of a large concert hall. Suitable for classical music. A long delay time of reflected sounds, coupled with reverb effects, let the listener enjoy the dynamic and rich sounds characteristic of concert halls and powerful orchestral performances.

### HALL 2

Simulates the acoustic environment of a very resonant concert hall. Rich reverberation and a full sound create the impression of a lively performance space.

### JAZZ

Simulates the acoustic effects of a jazz club. Reflected sound is virtually below 100 msec so that the listener can enjoy a live band effect.

### DANCE

Simulates the acoustic effects of a dance club. Features a strong bass sound. Reflected sound delay time is virtually below 50 msec, for the listener to enjoy the visceral power of dance music.

### THEATER 1

Reproduces theater sound field effects without losing the localization of each channel. Theater effects can be enjoyed without losing Dolby Digital/ Pro Logic effects when used in combination those formats (with movies bearing the  trademark).

### THEATER 2

Simulates the acoustic environment of a theater while maintaining proper localization of each channel.

### 5/7CH STEREO

Simulates the acoustic environment of a regular stereo while using all the speakers in the system to induce a rich, all-around sound. If you have SURROUND BACK speakers switched on (see p. 33– 34) then the name of this mode will be 7CH STEREO in the display on the receiver. If the SURROUND BACK speakers are switched off, then the mode will appear as 5CH STEREO.

## STEREO mode

Use the STEREO mode to enjoy standard (two-channel) stereo sound from the front left and right speakers. This mode is most like the sound reproduction you would get from a regular stereo receiver or amplifier that is not equipped to handle A/V formats as this one is. You might want to use this mode for listening to regular music sources (like CDs) but remember, you will only get sound from your front two speakers (and possibly your subwoofer).

# Selecting a Sound Mode

To ensure the best possible surround sound, be sure to complete the set up procedures described in "Setting Up for Surround Sound" (starting on p. 27) before using the sound modes. This is particularly important when using the **DD** (Dolby) Digital, DTS or MPEG sources. When using the sound modes, using SPEAKERS A will give the best results. If you use SPEAKERS B the sound will be down mixed to the two front B speakers and the surround sound effect for the center, surround and/or surround back speakers will be lost.

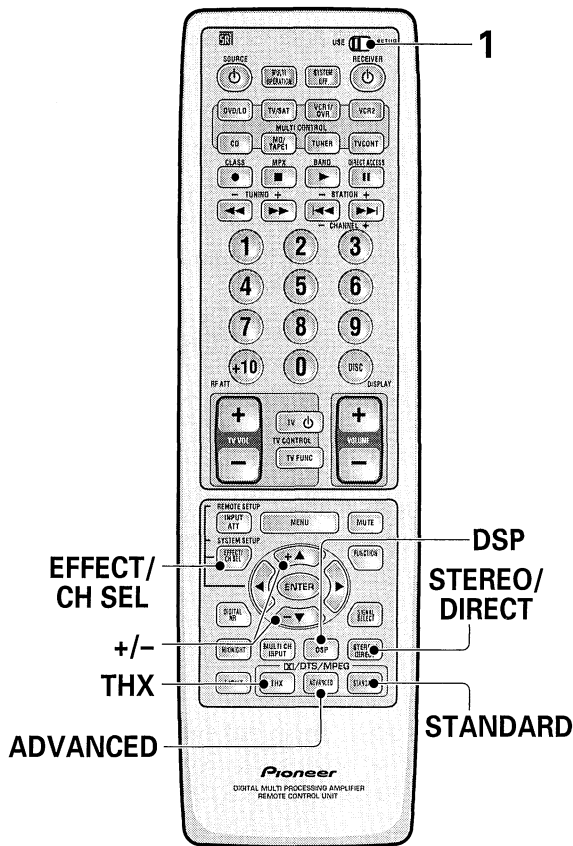

**1 Set the slide switch on the remote control to USE.**

**2 Select a sound mode.**

- For STANDARD → Press STANDARD  
Each press changes the STANDARD mode as follows:  
**[When using SURROUND BACK speakers]**



- [When using no SURROUND BACK speakers]**  
STANDARD only

- For HOME THX CINEMA → Press THX (THX CINEMA)  
Each press changes the THX mode as follows:  
**[When using SURROUND BACK speakers]**

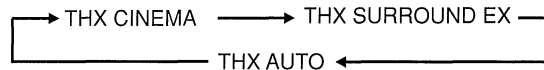

- [When using no SURROUND BACK speakers]**  
THX CINEMA only

- For ADVANCED THEATER → Press ADVANCED THEATER (ADVANCED)  
Each press changes the ADVANCED THEATER mode as follows:

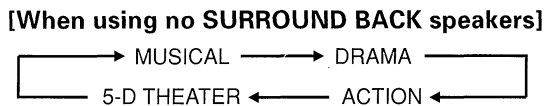
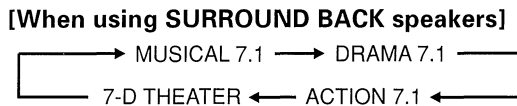

- For DSP modes → Press DSP (DSP MODE) repeatedly  
Each press changes the DSP mode as follows:

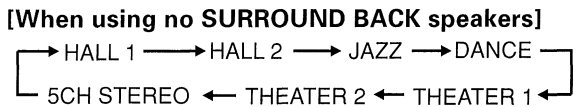
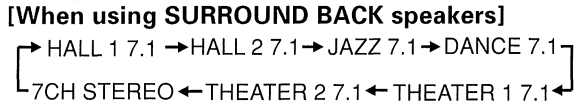

- For STEREO → Press STEREO (STEREO/DIRECT)  
Each press changes the STEREO mode as follows:

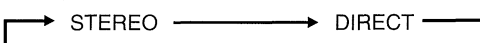

■ OFF — ON button

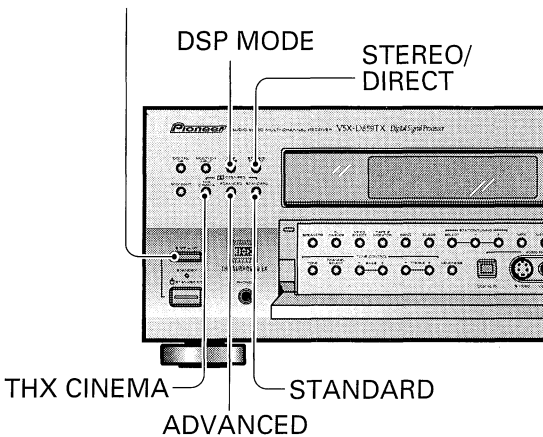

- If you have SURROUND BACK speaker(s) switched on (see p. 33 – 34) then 7-D THEATER and 7CH STEREO will appear as such in the display on the receiver. If these speakers are not switched on the above two modes will appear as 5-D THEATER and 5CH STEREO.
- The amount of effect in each ADVANCED THEATER mode can be adjusted in the range of 10 to 90 by pressing EFFECT +/- (The default setting is 70). Also, the effect level can be set in each ADVANCED THEATER mode by pressing the EFFECT(+/-) button (see p. 24).
- The amount of effect in each DSP mode can be adjusted in the range of 10 to 90 (the default setting value is 70) by pressing EFFECT +/- (see p. 24).
- 5/7CH STEREO modes cannot be adjusted.

# Playing Sources with Dolby Digital, DTS or MPEG Audio

This page covers using your receiver with Dolby Digital, DTS or MPEG audio encoded sources.

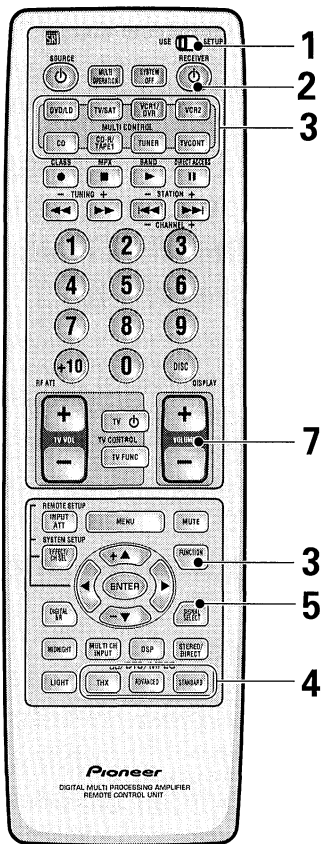

**1 Set the slide switch on the remote control to USE.**

**2 Turn on the  RECEIVER.**

**3 Press the MULTI CONTROL buttons or the FUNCTION button (or turn the MULTI JOG dial) to select the source you want playback.**

The FUNCTION button cycles through the sources in the following order:

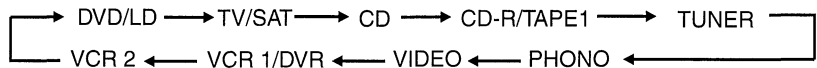

**4 Choose a sound mode by pressing THX, ADVANCED THEATER or STANDARD.**

The default setting is STEREO.

(For more see "Sound Modes" and "Selecting a Sound Mode" on pages 41 – 44.)

**5 Press the SIGNAL SELECT button to select the input signal. Set to AUTO.**

(See "Switching Analog and Digital Signal Input" on page 47.)

**6 Start playback of the component you selected in step 3.**

**7 Adjust the volume by using the volume buttons on the remote control or the MASTER VOLUME on the front panel.**

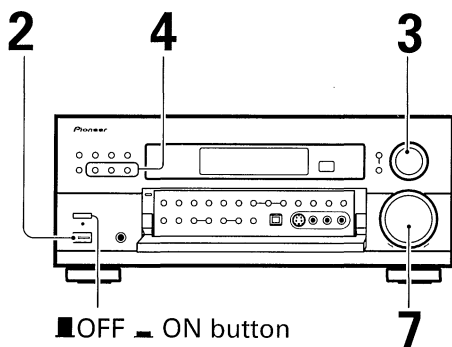

- We recommend using different modes for different types of DTS material. For watching movies, the THX or ADVANCED THEATER setting should provide the best results. For listening to music, the STANDARD, DIRECT, STEREO, or DSP modes should serve the listener best.
- Make sure you connect your DVD/LD or LD player with the RF demodulator. If your player has an  RF output this will ensure you can use all LDs. Refer to p. 13.
- Some DVD players don't output DTS signals. For more details, refer to the instruction manual supplied with your DVD player.
- If you are not able to get sound from the receiver the problem may well lie with the SIGNAL SELECT button. You need to make sure the input is set to the appropriate ANALOG or DIGITAL setting. Refer to p. 47 for more on this.

## Playing Stereo Sources

The following instructions show you how to use the receiver for stereo audio or audio-visual.

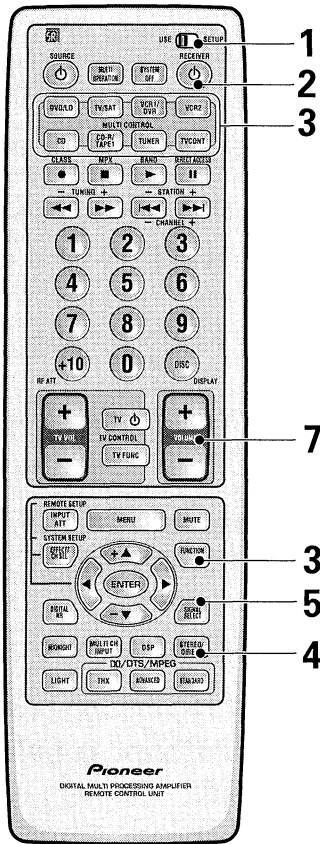

**1 Set the slide switch on the remote control to USE.**

**2 Turn on the  RECEIVER.**

**3 Press the MULTI CONTROL buttons or the FUNCTION button (or turn the MULTI JOG dial) to select the source you want to playback.**

The FUNCTION button cycles through the sources in the following order:

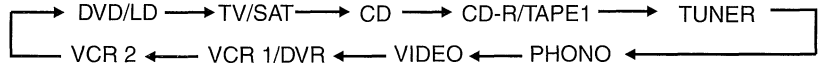

**4 Press the STEREO/DIRECT button to select the stereo mode.**

The STEREO indicator lights on the display.

**5 Press the SIGNAL SELECT button to select the input signal. Set to AUTO.**

(See "Switching Analog and Digital Signal Input" on page 47.)

**6 Start playback of the component you selected in step 3.**

**7 Adjust the volume by using the VOLUME buttons on the remote control or the MASTER VOLUME on the front panel.**



If you are not able to get sound from the receiver the problem may well lie with the SIGNAL SELECT button. You need to make sure the input is set to the appropriate ANALOG or DIGITAL setting. Refer to p. 47 for more on this.

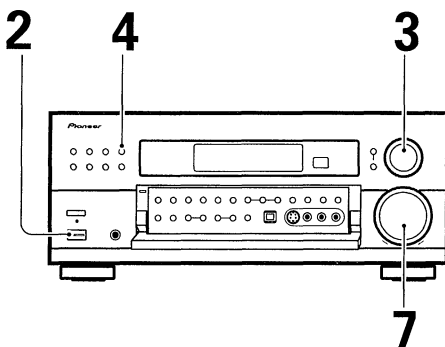

## Switching Analog and Digital Signal Input

This switch moves the input fed to the receiver between analog and digital sources. You need to take special care to switch to the appropriate input, when necessary. For example, the switch would have to be on DIGITAL to use DOLBY DIGITAL, DTS or MPEG surround sound but it would have to be on ANALOG to record to the analog out jacks on the receiver. The default setting is AUTO (priority is given to a digital signal, if there is one).

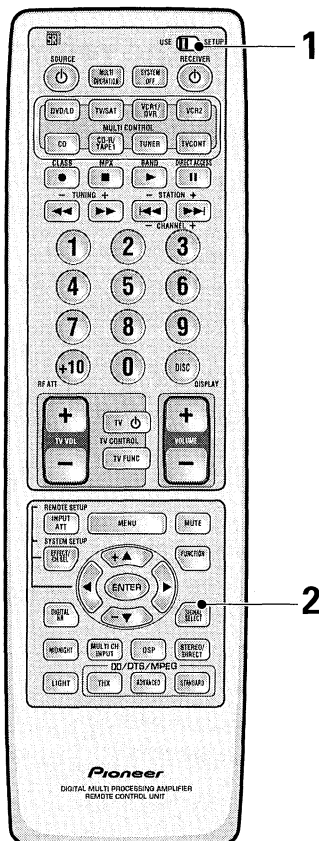

**1 Set the slide switch on the remote control to USE.**

**2 Press the SIGNAL SELECT button to select the input signal corresponding to the source component.**

Each press switches the signal in the order below:

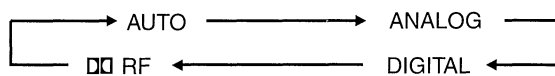

**3 If SIGNAL SELECT is set to DIGITAL,  DIGITAL lights when a Dolby Digital signal is input; DTS lights when a DTS signal is input; MPEG lights when a MPEG signal is input.**

When a DTS signal is input.

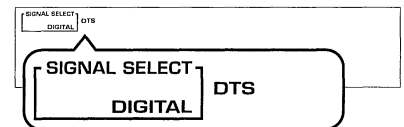

When a Dolby Digital signal is input.

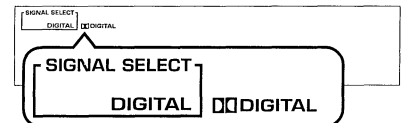

When a MPEG signal is input.

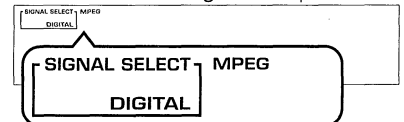

- In the AUTO setting, SIGNAL SELECT gives priority to the signal in the following order:  RF, DIGITAL, ANALOG.
- If the Digital-In Select (see p. 30) choices are set to OFF, the SIGNAL SELECT will default to ANALOG.
- Because the audio from a karaoke microphone and LD recorded with analog audio only is not output from the digital output, set SIGNAL SELECT to ANALOG.
- This receiver can only playback Dolby Digital, PCM (32kHz, 44kHz, 48kHz, and 96kHz), DTS and MPEG digital signal formats. If you have some equipment that outputs digital audio in a format other than these you'll have to connect and playback via the receiver's analog inputs (make sure that SIGNAL SELECT is set to ANALOG).
- When an LD or CD with DTS is played back with the SIGNAL SELECT set in ANALOG, digital noise caused by playing back the DTS directly (with no decoding) is output. To prevent noise, you need to make digital connections (See p. 12-13) and set SIGNAL SELECT to DIGITAL or AUTO.
- Some DVD players don't output DTS signals. For more details, refer to the instruction manual supplied with your DVD player.
- The levels between analog and digital sources may vary so be careful with volume levels when switching between these two.

## Reducing Noise During Playback

To reduce extraneous noise switch on DIGITAL NR. This noise reduction can be used with every mode except MULTI CHANNEL IN and DIRECT.

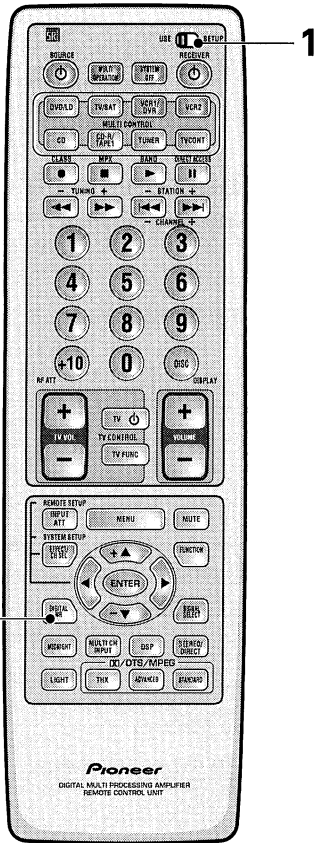

**1 Set the slide switch on the remote control to USE.**

**2 Press the DIGITAL NR button on the remote control or on the front panel.**

Each press switches the DIGITAL NR between on or off.



- In cases described below, noises may not be reduced even if DIGITAL NR is on.
  - Sudden noise
  - Extremely loud noise
  - Signals that do not contain many high frequencies
- DIGITAL NR is effective at and above levels shown below for each source.
- STEREO
  - analog input..... 10 -18 dB
  - digital input..... 10 -15 dB
  - AM/FM tuner ..... 10 -15 dB
- DSP/ADVANCED/STANDARD/96kHz stereo ..... 6 -10 dB
- Depending on the condition of the source, there may not be a noticeable improvement in the quality of the sound.
- You can't use the DIGITAL NR mode with the THX, MULTI CH IN or DIRECT mode.
- If you press DIGITAL NR when in DIRECT mode the receiver switches to STEREO mode.

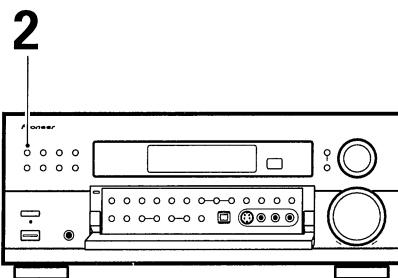



## Listening in Midnight Mode

This feature makes it possible to get excellent surround sound effects even when listening at low volumes. It can be used with a variety of surround sound sources and plays soundtracks so that the quieter sounds are audible while the noisier sounds don't become overly loud or distorted. It does this by bringing all the sounds in a given soundtrack closer together in volume. Compare this feature with the D-Range Control (only for Dolby Digital sources) on page 40.

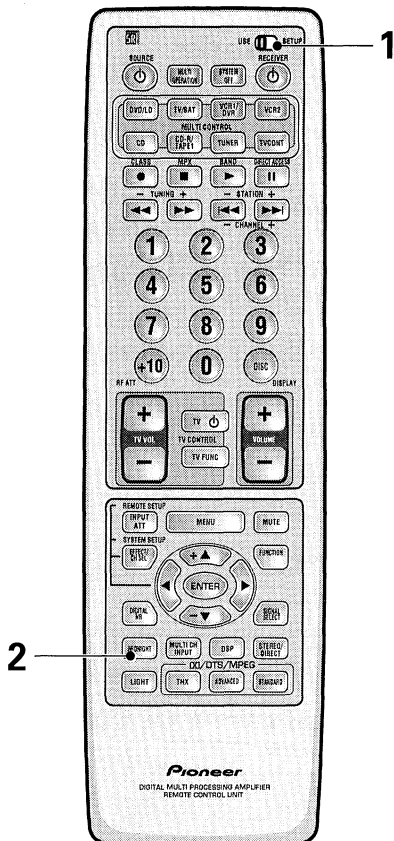

**1 Set the slide switch on the remote control to USE.**

**2 Press the MIDNIGHT button.**

Each press switches the MIDNIGHT LISTENING mode between on or off.



- The effect adjusts itself automatically in accordance with the volume level.
- You can't use the MIDNIGHT LISTENING mode with the THX, MULTI CH IN or DIRECT mode.
- If you use MIDNIGHT in DIRECT mode the receiver will switch to STEREO mode.

2

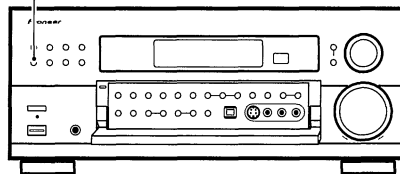

## Listening the Loudness Mode

The LOUDNESS mode allows you to boost the bass in a signal. It is useful for listening to music at low volumes.

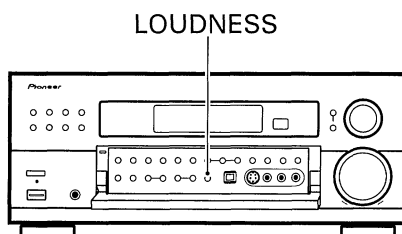

**Press the LOUDNESS button.**

Each press switches the LOUDNESS mode between on and off.

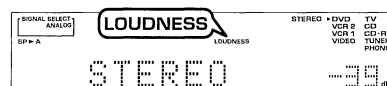

- You can't use the LOUDNESS mode with the MULTI CH IN, THX or DIRECT mode.
- If you press LOUDNESS in DIRECT mode the receiver will switch to STEREO mode.

## Adjusting Bass and Treble

You can use BASS +/- or TREBLE +/- buttons to adjust the low and high frequencies for each individual set of speakers. If the receiver is in STEREO mode you can only adjust the FRONT speakers. In a surround mode (STANDARD, ADVANCED THEATER, etc.) you can adjust the FRONT, CENTER, SURROUND and SURROUND BACK speakers. The TONE button can also be used to bypass the tone circuitry (see #20, p. 22).

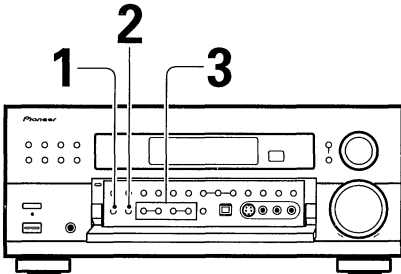

- 1 Press the **TONE** button on the front panel to put the receiver in **TONE ON** mode.

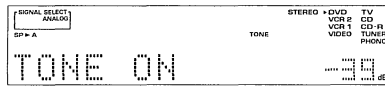

- 2 Press the **CHANNEL SELECT** button on the front panel to cycle through the different tone adjust modes.

The button cycles through the possibilities in the following order:

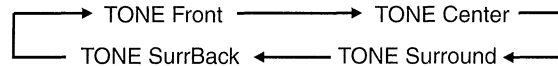

[When not using **SURROUND BACK** speakers]

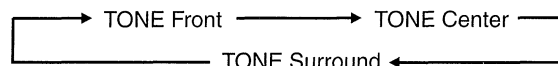

- 3 Use the **BASS** or **TREBLE (+/-)** buttons to adjust the low or high frequencies of each channel.

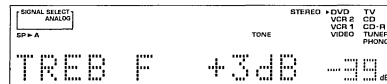

A few seconds after you finish adjusting the tone the receiver will revert to the sound mode it was in at the beginning of the process.



- The tone can be adjusted in a range of  $\pm 6$  dB.
- The tone cannot be adjusted in THX and MULTI CH IN modes.
- When you press the TONE button in DIRECT mode the receiver switches to STEREO mode and TONE ON appears in the display. You can now change the TONE setting (note the receiver is no longer in DIRECT mode).

# MULTI CHANNEL IN Playback

MULTI CH IN allows you to connect an external decoder to enjoy certain types of specialized discs. To use MULTI CH playback follow the instructions below.

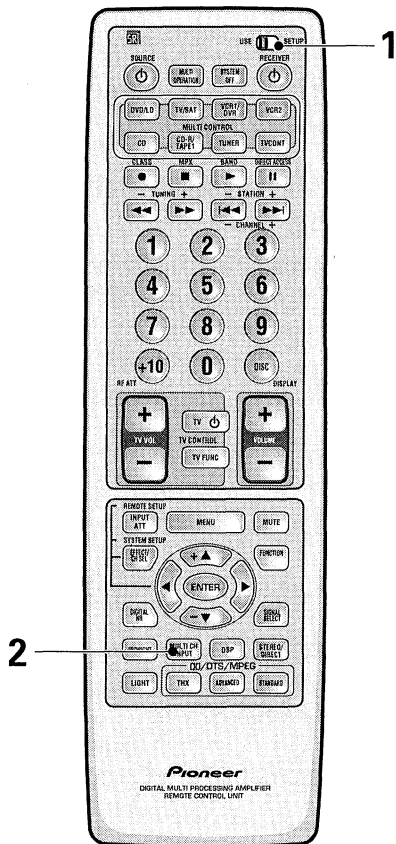

**1 Set the slide switch on the remote control to USE.**

**2 Press the MULTI CH INPUT button on the remote control or the front panel.**

Each press switches the input between the previous mode and MULTI CH IN.



When MULTI CH IN is selected only the volume level and channel levels can be set (see p. 31). All of this unit's other features (DSP modes, ADVANCED THEATER modes, DIRECT mode, TONE controls, etc.), as well as the TUNER and PHONO modes, cannot be used. Also, all speaker settings and other setup settings have no effect.

MULTI CH INPUT

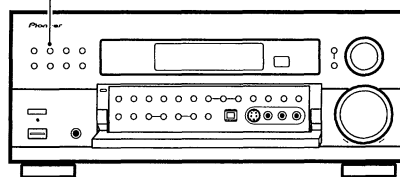

## 96kHz 24 bit Performance

This receiver is capable of playing back advanced DVD discs which are recorded in 96 kHz/24 bit format (these are all stereo discs) and any source recorded in 96 kHz and up to 24 bit. The receiver will automatically read the format of the source and play accordingly (of course the SIGNAL SELECT will have to set to AUTO or DIGITAL to read the DVD soundtrack). When the receiver plays a 96 kHz disc "96 kHz" and "STEREO" will appear in the display.



- When a 96 kHz/24 bit disc is played back the volume may be louder than that of a normal disc.
- Some DVD players cannot play 96 kHz/24 bit discs. Check the manual of your DVD player to make sure.
- During this playback the player enters the STEREO mode and you can use the controls available in STEREO mode (LOUDNESS, MIDNIGHT, TONE controls, etc., see p. 49 – 50).
- With 96 kHz/24 bit discs you are able to use MULTI CH IN playback and the TAPE 2 MONITOR.
- In 96 kHz/24 bit mode you can't use the STANDARD, ADVANCED THEATER, THX or DSP modes.

## Direct Playback

This mode is for playing back a sound source in its purest form, no tone adjustments or other sound modes can be used.

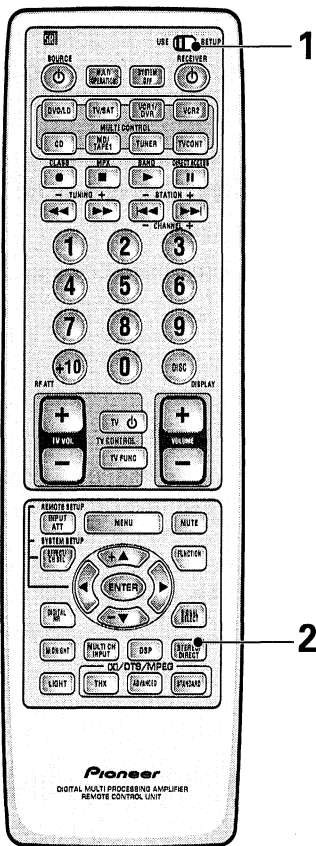

**1 Set the slide switch on the remote control to USE.**

**2 Use the STEREO/DIRECT button to alternate between STEREO or DIRECT mode (you can also use the STEREO/DIRECT button on the front panel).**

The DIRECT mode will give you the most accurate reproduction of two channel (stereo) sources but won't let you add any effects to the sound.

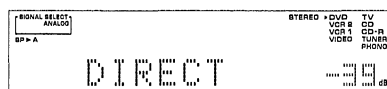

- None of the tone controls or other sound modes can be used with DIRECT playback.
- If the receiver is in a different mode than STEREO to start with the first push of the STEREO button will put it in STEREO mode. After that the button will toggle the receiver between STEREO and DIRECT mode.
- For more on this button see the explanation of STEREO mode on p. 43-44, 46.

STEREO/DIRECT

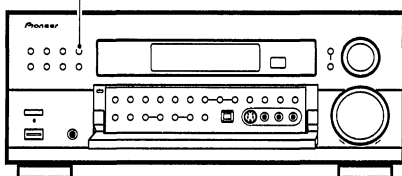

## Adjusting the Brightness of the Display

Use the FL DIMMER button to adjust the brightness of the fluorescent display (FL=fluorescent display).

FL DIMMER

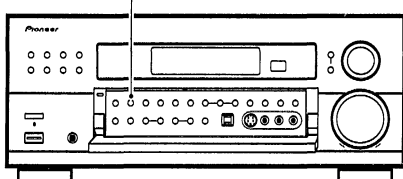

**Press the FL DIMMER button on the front panel.**

Four levels of brightness ranging from very dim to very bright can be selected. Each press changes the brightness of the display. When rotating through the options, the default brightness can also be selected.



Please note: it is a feature of this unit that the fluorescent display will be brighter for a few seconds after you choose a function (like DVD/LD, CD, etc.) and then get softer. This will still happen when you adjust the brightness but the new setting will be the one the display softens to.

## DUAL MONO setting

The dual mono setting can only be used when listening to Dolby Digital discs that have dual mono software encoded in them. Dual mono software usually is used to put two different soundtracks on one DVD. With this setting you can choose which channel in the dual mono setting you want to listen to. Thus, it is useful for soundtracks that have one language on one channel and a different language on the other. Remember this setting is only applicable if you are using Dolby Digital software with dual mono and want to isolate one of the channels therein. Otherwise, just ignore this function.

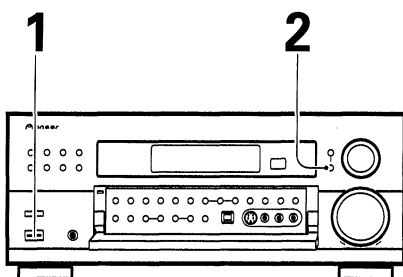

### 1 Turn the receiver ON.

### 2 Hold down the RETURN button for 3 or 4 seconds. The receiver will cycle through the three different dual mono settings for as long as you hold the button down.

Take your finger off the button when the mode that you want to use is displayed.



DUAL ch1 setting



DUAL ch2 setting

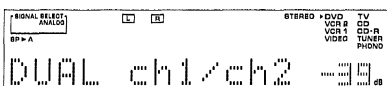

DUAL ch1/ch2 setting

The different settings are: DUAL ch1, where you only hear channel 1; DUAL ch2, where you only hear channel 2; and DUAL ch1/ch2, where you hear both channels, but independently from different speakers.

The display will show dual mono for a while then revert to the sound mode you are in but you will still be listening to dual mono.



The default setting is DUAL ch1.

When DUAL MONO is playing with ch 1 selected the L will light.  
When playing with ch 2 selected the R will light.

When playing with ch 1/2 selected the L and R will light.

# Using the Tuner

## Automatic and Manual Tuning

The following steps show you how to tune in FM and AM radio broadcasts using the automatic (search) and manual (step) tuning functions. If you already know the exact frequency of the station you desire, see "Direct Access Tuning" on the following page.

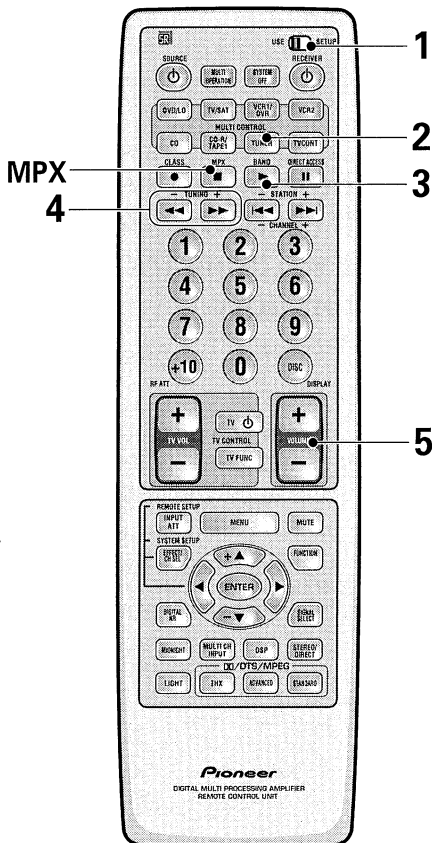

**1 Set the slide switch on the remote control to USE.**

**2 Press the TUNER button.**

On the remote, this selects the TUNER function on the receiver and sets the remote to the TUNER operation mode.

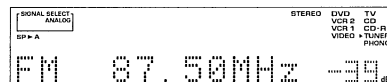

**3 Press BAND button on the remote or the front panel to select the band (FM or AM).**

Each press switches the band: FM ↔ AM

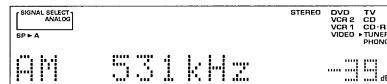

**4 Tune in the station.**

**For Automatic Tuning**

Press and hold TUNING  $\pm$  buttons for about one second, then release.

The tuner starts searching the selected band and stop automatically at the first station it locates. Repeat to locate other stations.

**For Manual Tuning**

- To change frequencies one step at a time, press TUNING  $\pm$  repeatedly.
- To change frequencies quickly, hold down TUNING  $\pm$  and release when you reach the frequency you desire.

**5 Adjust the MASTER VOLUME buttons on the remote control or the MASTER VOLUME on the front panel.**

### MPX mode

If the TUNED or STEREO indicators do not light when tuning an FM station, because the station is too far away or the broadcast signal is weak, press MPX on the remote control or front panel to switch to MONO reception. This should improve reception enough for you to enjoy the broadcast.

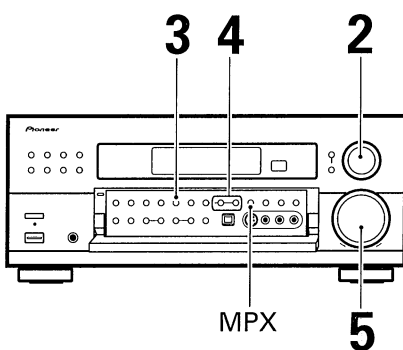

## Direct Access Tuning

The following steps show you how to tune directly to a specific frequency using the remote control.

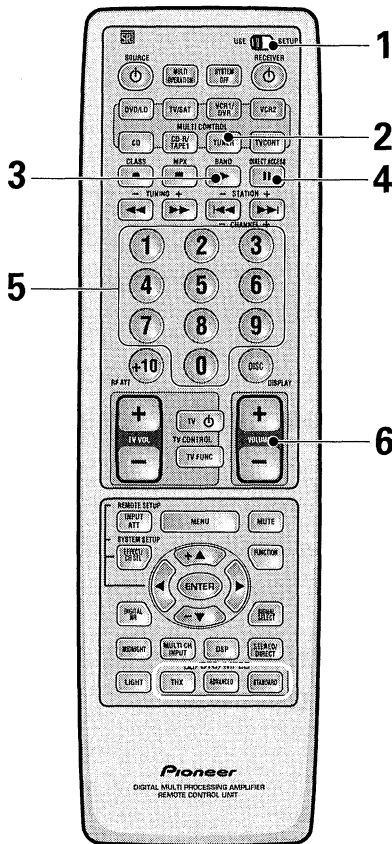

**1 Set the slide switch on the remote control to USE.**

**2 Press the TUNER button.**

This selects the TUNER function on the receiver and sets the remote to the TUNER operation mode.

**3 Press the BAND button on the remote or the front panel to select the band (FM or AM).**

Each press switches the band: FM ↔ AM

**4 Press DIRECT ACCESS button to activate the direct Access tuning mode.**

The cursor blinks in the display on the front panel.

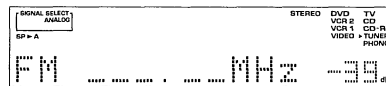

**5 Use the NUMBER buttons to enter the frequency of the station you want.**

**Example:**

To tune station 106.00 (FM), press:

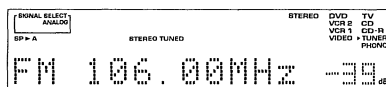

**To cancel before inputting the frequency**

Press DIRECT ACCESS button, and enter the frequency again.

**6 Adjust the MASTER VOLUME buttons on the remote control or the MASTER VOLUME on the front panel.**

# Memorizing Frequently Used Stations

The following steps show you how to memorize up to 30 radio stations in 3 classes (each holding 10 channels). When memorizing FM frequencies, the receiver also memorizes the MPX mode (STEREO or MONO).

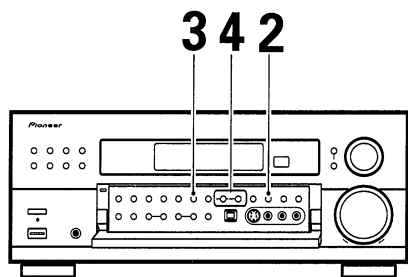

### 1 Tune in the desired station.

See "Automatic and Manual Tuning" or "Direct Access Tuning" on p. 54 and 55.

### 2 Press the MEMORY button to activate the memory function.

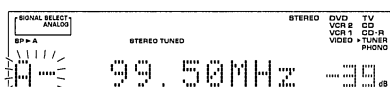

### 3 Press the CLASS button repeatedly to select a class number.

Each press switches the display as follows:

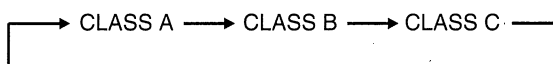

### 4 Press the STATION -/+ buttons repeatedly to select a channel (0~9) within the respective class.

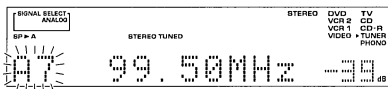

The station is memorized automatically after 5 seconds.

**If you want to escape from MEMORY mode**

Press the MEMORY button again.

**Repeat steps 1 through 4 to memorize up to 30 stations.**



# Recalling Memorized Stations

## Using the remote control

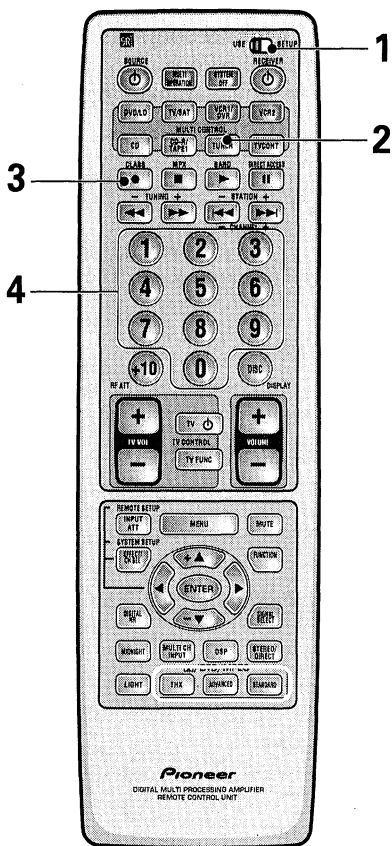

**1 Set the slide switch on the remote control to USE.**

**2 Press the TUNER button or turn the MULTI JOG to select the TUNER function.**

This selects the TUNER function on the receiver and sets the remote to the TUNER operation mode.

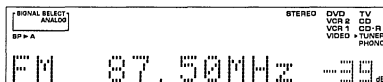

**3 Press the CLASS button repeatedly to select a class number.**

Each press switches the display as follows:

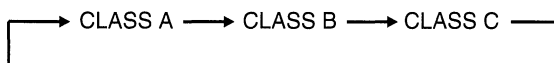

**4 Use the NUMBER buttons (or STATION +/- buttons) to select the channel you want.**

To select channel 7, press **7**.

To select channel 0, press **0**.

For example : If 99.50 MHz (FM) was memorized in class A at channel 7.

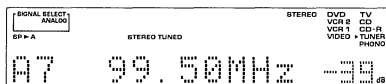

**To skip through each channel in order**

Press STATION -/+ repeatedly.

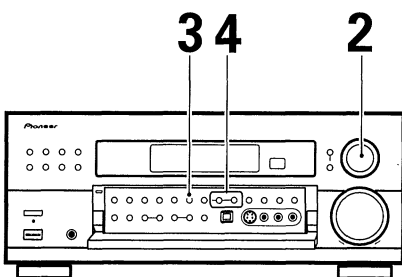

# Remote Control of Other Components

## Setting Up the Remote Control to Control Other Components

In addition to controlling the receiver, the supplied remote control can operate your other components (VCR, TV, LD, CD, etc.) after you program it to do so. In this way, instead of fumbling with many different controls and buttons, you only need to use one remote control. If your component(s) are listed in the remote control's memory, simply follow the steps below. If your component(s) are not listed, or if you want the remote to learn additional operations, you can use the learning mode to input the information from the remote controls supplied with your other components.

### Recalling Preset Codes

The following steps show you how to recall preset codes stored in the remote control. Once a preset code is recalled and the component assigned, you can use this remote to easily operate the component. See "Preset Code List" on page 85–87 for the components and manufacturers available.

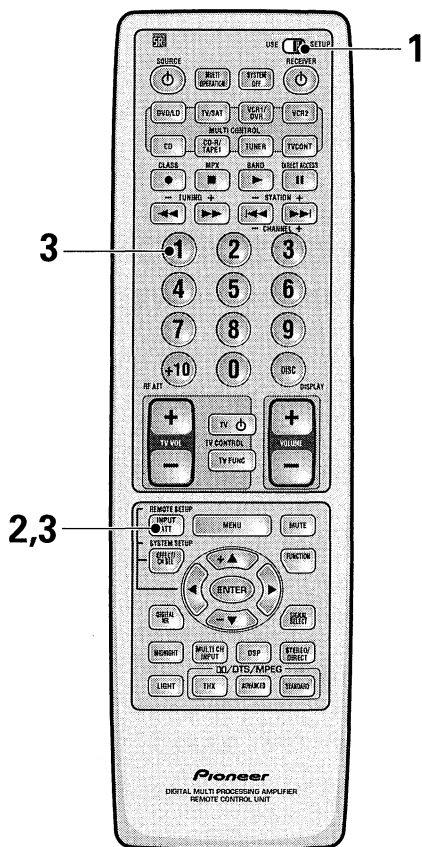

### 1 Set the remote control slide switch to **SETUP**.

Also make sure that your TV is on and set to the receiver.

### 2 Press the **REMOTE SETUP (INPUT ATT)** button.

The REMOTE SET UP menu appears on your TV screen.

```
Select Remote
Setup Mode

Remote Setup+1
Preset Recall
Remote Setup+2
Learning
Remote Setup+3
Multi-Operation
Remote Setup+4
Direct Function
```

You have four setup options:

- ① Preset Recall
- ② Learning
- ③ Multi Operations (See p. 75)
- ④ Direct Function (See p. 79)

Preset Recall and Learning are the two modes that teach the remote control to operate your other components. It's easiest to start with Preset Recall and, if setup isn't possible for certain components, move on to the Learning mode.

### 3 Press the **REMOTE SETUP** button and **①** at the same time to select the **preset recall setup mode**.

All the MULTI CONTROL buttons (except the TUNER button) start to blink.

**To cancel the preset recall setup mode press REMOTE SET UP.**

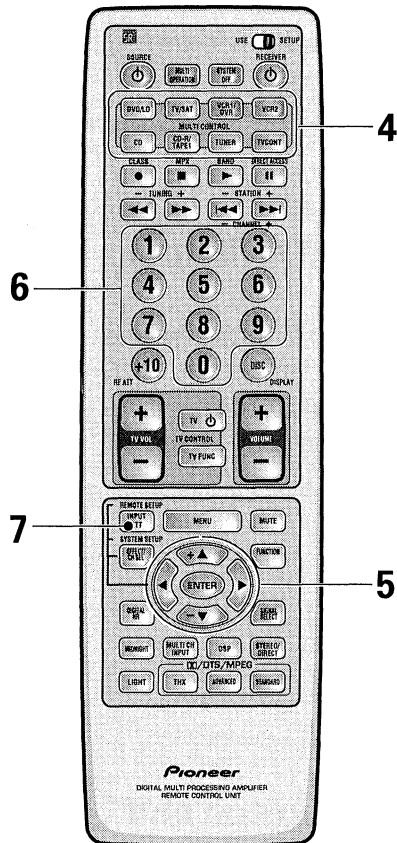

### 4 Press the MULTI CONTROL button for the component you want to control.

The button lights steadily and the first manufacturer and preset code(s) appear on your TV screen .

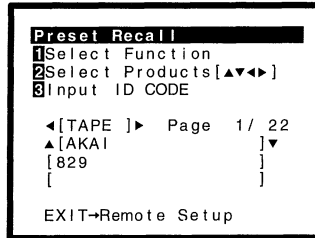

### 5 Press the ◀/▶ buttons to choose the function and then press the ▲/▼ buttons repeatedly to display the name of different manufacturers.

If your component is made by a small or relatively unknown-manufacturer you may not be able to find the code.

### 6 Point the remote toward the component to be controlled, enter the 3 digit setup code (see p. 85–87).

When you enter the setup code, the remote emits a power on/off signal. If the component turns on or off, you have entered the proper code (this is only possible for components with a standby setting). If there is no standby setting on the component you are trying to input, leave it on during this process and see if it turns off when the code is entered.

If the component does not turn on or off and there is more than one setup code, try inputting another code (starting again from step 4). Some manufacturers use several sets of remote control signals and the first code may not correspond to your component.

**Repeat steps 4 through 6 to assign preset codes for as many components as necessary.**

**If you can't get your component to respond to any of the codes see the next section.**

### 7 Press the RECEIVER button to exit the preset recall setup mode.

The remote control and TV return to their previous operation modes.

- When you're done setting up, remember to set the slide switch back to USE.
- To erase all the preset codes see p. 62.



The codes are listed in the back of the manual on p. 85–87. In this list the DVR codes are listed under the DVD and the VCR section, the DAT codes are listed under the MD section and the SAT codes are listed under the STB section.

## Remote Control of Other Components

### Learning commands from other remote controls

If preset codes are not available for your component(s), or the available preset codes do not operate correctly, you can use this function to program in signals from the remote control(s) of your other component(s). This operation can also be used after recalling a preset code to program additional operations not covered in the preset codes.

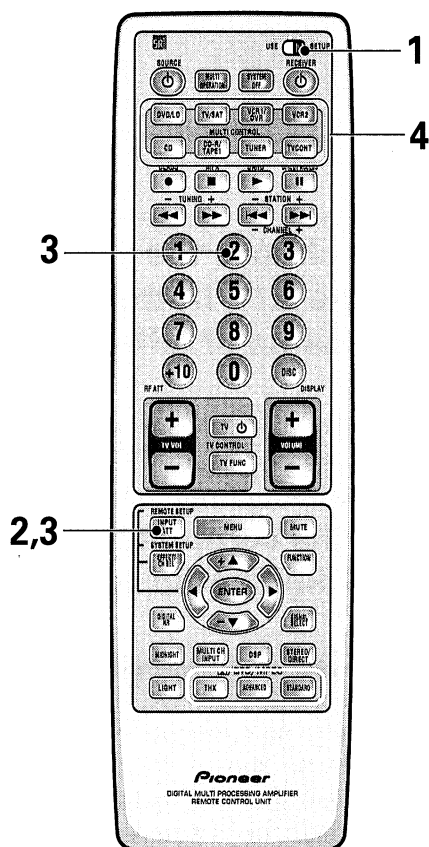

#### 1 Set the remote control slide switch to **SETUP**.

Also make sure that your TV is on and set to the receiver.

#### 2 Press the **REMOTE SETUP** button.

The REMOTE SET UP menu appears on your TV screen.

```
Select Remote
      Setup Mode

Remote Setup+1
  Preset Recall
Remote Setup+2
  Learning
Remote Setup+3
  Multi-Operation
Remote Setup+4
  Direct Function
```

#### 3 Press the **REMOTE SETUP** button and **2** at the same time to select the learning setup mode.

All the MULTI CONTROL buttons (except the TUNER button) start to blink.

To cancel learning setup mode, press the REMOTE SET UP button.

```
Learning Setup
1 Place both commanders
  pointing at each other.
2 Select the item from
  the Multi-Control
  buttons that should be
  duplicated. (ex. DVD)
Multi-Control button
  starts blinking.

EXIT→Remote Setup
```

#### 4 Press the **MULTI CONTROL** button for the component you want to control.

Each button can be set to control one of the following components

The selected button continues to blink.

```
Learning Setup
3 Press one button that
  should be duplicated.
4 Multi-Control button
  lights up.
5 Press one button on the
  original commander, and
  hold 2 to 10 seconds.
6 Repeat this process to
  duplicate next command.

EXIT→Remote Setup
```

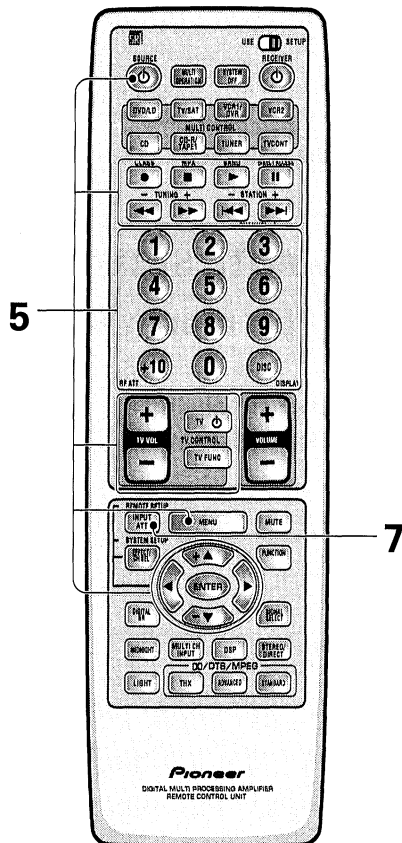

### 5 Press the button to be programmed.

The MULTI CONTROL button lights steadily.

- The TV POWER, TV FUNC and TV VOL +/- buttons are only available for learning when programming TV CONTROL operations.

### 6 Point the remote controls at each other and press the button on the other remote control for the operation you wish to program .

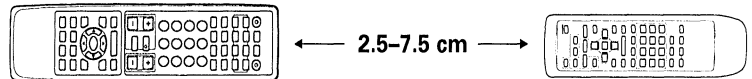

- ① Point the remote controls toward each other.
- ② Hold down the button on the other remote control corresponding to the operation you wish to program. Release when the MULTI CONTROL button on the receiver's remote control starts blinking.

(The MULTI CONTROL button blinks to indicate that the operation has been learned.)

**To program additional operations for the current component, repeat steps 5 and 6.**

**To program operations for another component, repeat steps 4 through 6.**

### 7 Press the REMOTE SETUP button to exit the learning setup mode.

The remote control and TV return to their previous operation modes.

- When you're done setting up, remember to set the slide switch back to USE.
- To erase programmed commands see p. 62.



Only the buttons identified with five in the illustration can be programmed.

### Clearing One of the Remote Control Settings

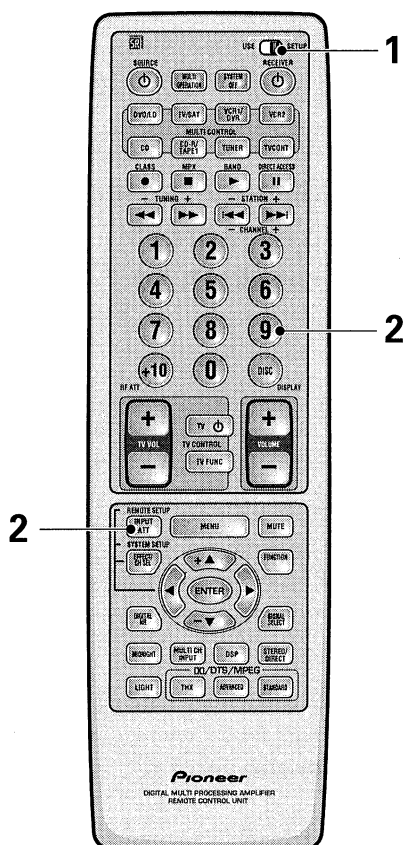

**1 Set the remote control slide switch to SETUP.**

**2 Press and hold both the REMOTE SETUP (INPUT ATT) button and 9 for more than 3 seconds.**

The MULTI CONTROL buttons will blink 3 times and all signals which have been learned from other remote controls will be erased.

- When you're done setting up, remember to set the slide switch back to USE.

### Clearing All the Remote Control Settings

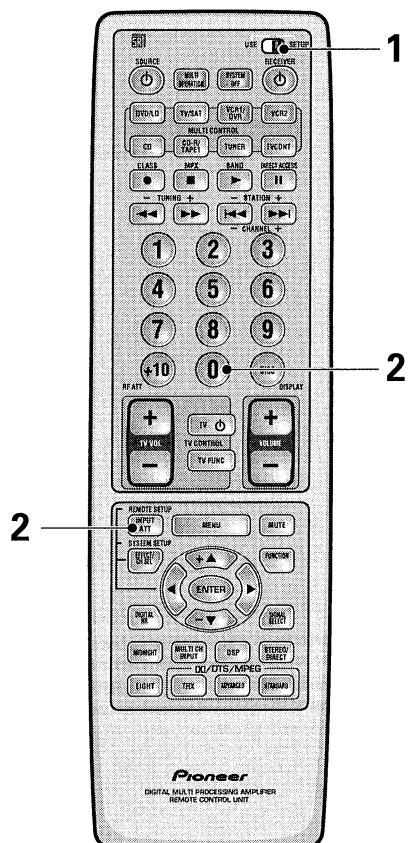

**1 Set the remote control slide switch to SETUP.**

**2 Press and hold both the REMOTE SETUP (INPUT ATT) button and 0 for more than 3 seconds.**

The MULTI CONTROL buttons, SYSTEM OFF button, and MULTI OPERATION button will blink 3 times and all preset and learned codes will be erased.

- When you're done setting up, remember to set the slide switch back to USE.

## Using the Remote Control with Other Components

### DVD or LD Player Operations

- The following operations are available from the receiver's remote control after you program your DVD or LD player's preset code, but some operations may need to be learned by the receiver (see "Setting Up the Remote Control to Control Other Components," on pages 58 – 61).
- To perform these operations, press the DVD/LD button to set the remote to the DVD or LD operation mode.
- For more information on individual commands consult the manual that came with the component.

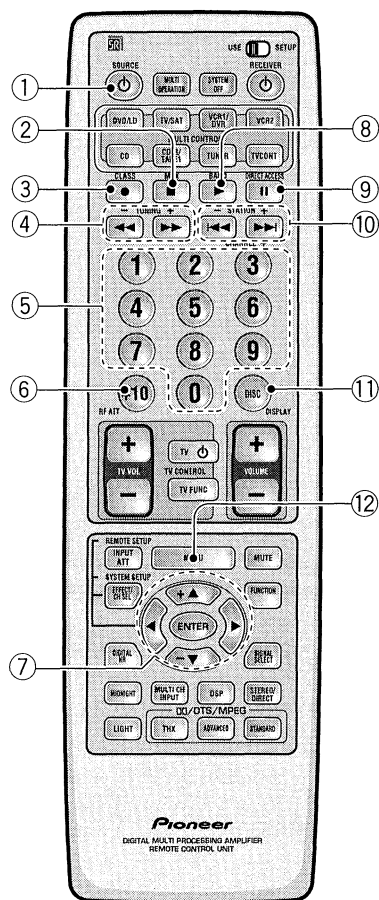

- ① **SOURCE**  
Press to switch the DVD or LD player on or off (not possible with all models, especially those without a standby mode).
- ② **■**  
Press to stop playback.
- ③ **● (TOP MENU)**  
Press to call up the menu programmed on the DVD (for DVD only).
- ④ **◀◀/▶▶**  
◀◀ : Hold down for fast reverse playback.  
▶▶ : Hold down for fast forward playback.
- ⑤ **Number buttons**  
Use to select chapters (tracks).
- ⑥ **+10**  
Use when selecting chapter (track) numbers higher than 10.
- ⑦ **▲/▼/◀/▶/ENTER**  
▲/▼/◀/▶ : Use to navigate through options on menu screens and to change settings.  
**ENTER** : Use to implement settings selected with the cursor buttons or to set items highlighted in a menu (for DVD only).
- ⑧ **▶**  
Press to start playback.
- ⑨ **||**  
Press to pause playback.
- ⑩ **◀◀◀/▶▶▶**  
◀◀◀ : Press to return to the beginning of the current chapter (track). Press repeatedly to return to the beginning of previous chapters (tracks).  
▶▶▶ : Press to advance to the beginning of the next chapter (track). Press repeatedly to advance to the beginning of following chapters (tracks).
- ⑪ **DISC (SIDE A/B)**  
Use to change the LD between sides A and B (for LD only).
- ⑫ **MENU**  
Displays menus concerning the current DVD you are using.

## Remote Control of Other Components

### VCR & DVD Recorder Operations

- The following operations are available from the receiver's remote control after you program your VCR or DVD video recorder's preset code, but some operations may need to be learned by the receiver (see "Setting Up the Remote Control to Control Other Components," on pages 58 – 61).
- To perform these operations, press the VCR 1 or VCR 2 button to set the remote to the VCR, DVD video recorder operation mode.
- For more information on individual commands consult the manual that came with the component.

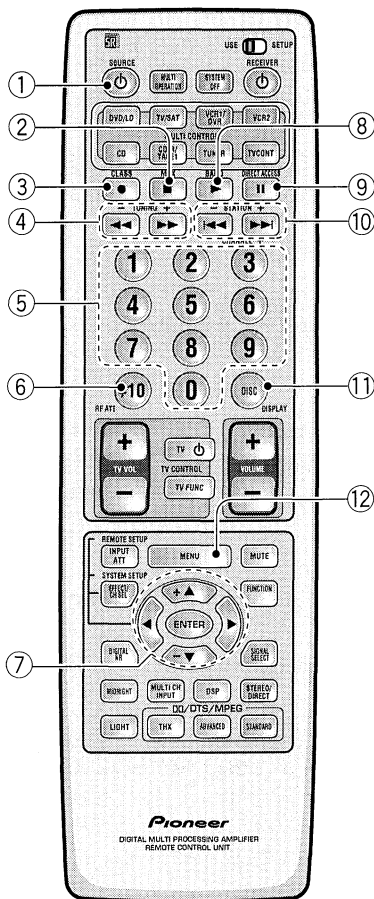

#### ① **⏻ SOURCE**

Press to switch the VCR or DVD video recorder on or off (not possible with all models, especially those without a standby mode).

#### ② **■**

Press to stop playback.

#### ③ **●**

Press to start recording.

#### ④ **◀◀/▶▶**

◀◀ : Hold down for fast reverse playback.

▶▶ : Hold down for fast forward playback.

#### ⑤ **Number buttons**

Use to select channels.

#### ⑥ **+10**

Use when selecting chapter (track) numbers higher than 10 (for DVD video recorder only).

#### ⑦ **▲/▼/◀/▶/ENTER**

▲/▼/◀/▶ : Use to navigate through options on menu screens and to change settings.

**ENTER** : Use to implement settings selected with the cursor buttons or to set items highlighted in a menu (for DVD video recorder only).

#### ⑧ **▶**

Press to start playback.

#### ⑨ **⏸**

Press to pause playback.

#### ⑩ **CHANNEL -/+**

Use to change channels on the VCR's tuner.

#### ⑪ **DISC (TV/VCR)**

Use this button to switch the VCR between its tuner (for watching videos) and the TV.

Press to stop recording (for DVD video recorder only).

#### ⑫ **MENU**

Use to display or close the title menu screen (for DVD video recorder only).



### CD/CD-R Player Operations

- The following operations are available from the receiver's remote control after you program your CD player's preset code, but some operations may need to be learned by the receiver (see "Setting Up the Remote Control to Control Other Components," on pages 58 – 61).
- To perform these operations, press the CD button to set the remote to the CD operation mode.
- For more information on individual commands consult the manual that came with the component.

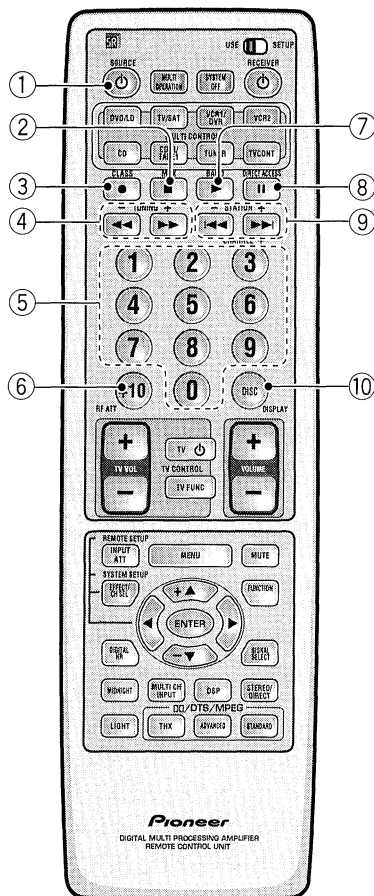

#### ① **SOURCE**

Press to switch the CD player/recorder on or off (not possible with all models, especially those without a standby mode).

#### ② **■**

Press to stop playback.

#### ③ **●**

Press to start recording (CD-R only).

#### ④ **◀▶**

◀◀: Hold down for fast reverse playback.

▶▶: Hold down for fast forward playback.

#### ⑤ **Number buttons**

Used to directly access tracks on a program source.

#### ⑥ **+10**

Use this button to select tracks higher than 10. Press this button and the remaining number to get the track (+10 Button + 3 = track 13).

#### ⑦ **▶**

Press to start playback.

#### ⑧ **||**

Press to pause playback.

#### ⑨ **|◀▶|**

|◀◀: Press to return to the beginning of the current track.

Press repeatedly to return to the beginning of previous tracks.

▶▶|: Press to advance to the beginning of the next track. Press repeatedly to advance to the beginning of following tracks.

#### ⑩ **DISC**

Use to switch between discs in file type disc play.

## Remote Control of Other Components

### MD Operations

- The following operations are available from the receiver's remote control after you program your MD recorder's preset code, but some operations may need to be learned by the receiver (see "Setting up the Remote Control to Control Other Components," on pages 58 – 61).
- To perform these operations, press the CD-R/TAPE 1 button to set the remote to the MD operation mode.
- For more information on individual commands consult the manual that came with the component.

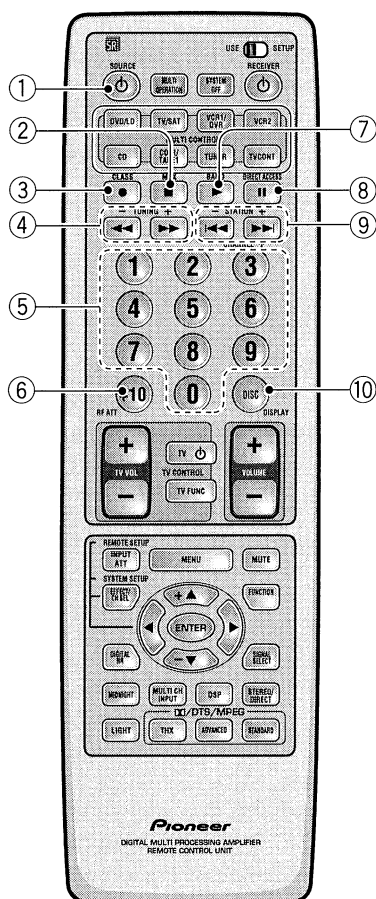

#### ① **SOURCE**

Press to switch the MD player on or off (not possible with all models, especially those without a standby mode).

#### ② **■**

Press to stop playback or recording.

#### ③ **●**

Press to start recording (may put some decks in REC PAUSE mode).

#### ④ **◀◀/▶▶**

◀◀ : Hold down for fast reverse playback.

▶▶ : Hold down for fast forward playback.

#### ⑤ **Number buttons**

Used to directly access tracks on a program source.

#### ⑥ **+10**

Use this button to select tracks higher than 10. Press this button and the remaining number to get the track (+10 Button + 3 = track 13).

#### ⑦ **▶**

Press to start playback.

#### ⑧ **||**

Press to pause playback.

#### ⑨ **◀◀/▶▶|**

◀◀ : Press to return to the beginning of the current track.

Press repeatedly to return to the beginning of previous tracks.

▶▶| : Press to advance to the beginning of the next track. Press repeatedly to advance to the beginning of following tracks.

#### ⑩ **DISC (DISP/CHARA)**

Allows you to change the display mode of the MD.

## STB (satellite tuner) Operations

- The following operations are available from the receiver's remote control after you program your satellite tuner's (or cable TV's) preset code, but some operations may need to be learned by the receiver (see "Setting Up the Remote Control to Control Other Components," on pages 58 – 61).
- To perform these operations, press the TV/SAT button to set the remote to the SAT operation mode.
- For more information on individual commands consult the manual that came with the component.

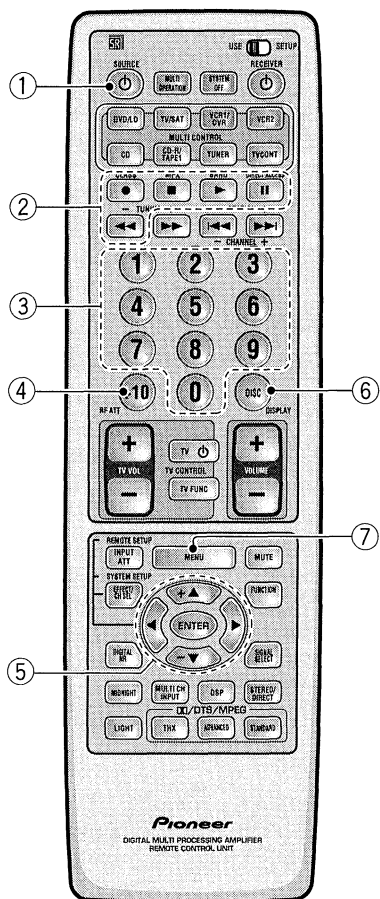

- ① **⏻ SOURCE**  
Press to switch the satellite tuner on or off (not possible with all models, especially those without a standby mode).
- ② **●/■/▶/⏸/◀◀ (A/B/C/D/E)**  
Use to make selections from Satellite functions.
- ③ **Number buttons**  
Use to select satellite channels.
- ④ **+10 (GUIDE)**  
Use to turn the program information screen on or off.
- ⑤ **▲/▼/◀/▶/ENTER**  
▲/▼/◀/▶ : Press the button to select items on the SAT GUIDE screen or SAT MENU screen.  
**ENTER** : Press to activate the selected function.
- ⑥ **DISC (EXIT)**  
Press to exit the current setting of the SAT.
- ⑦ **MENU**  
Use to turn the main menu on or off.

## Remote Control of Other Components

### TV Operations

- The following operations are available from the receiver's remote control after you program your TV's preset code, but some operations may need to be learned by the receiver (see "Setting Up the Remote Control to Control Other Components," on pages 58 – 61).
- To perform these operations, press the TV/SAT and TV CONT button to set the remote to the TV operation mode.
- For more information on individual commands consult the manual that came with your TV.

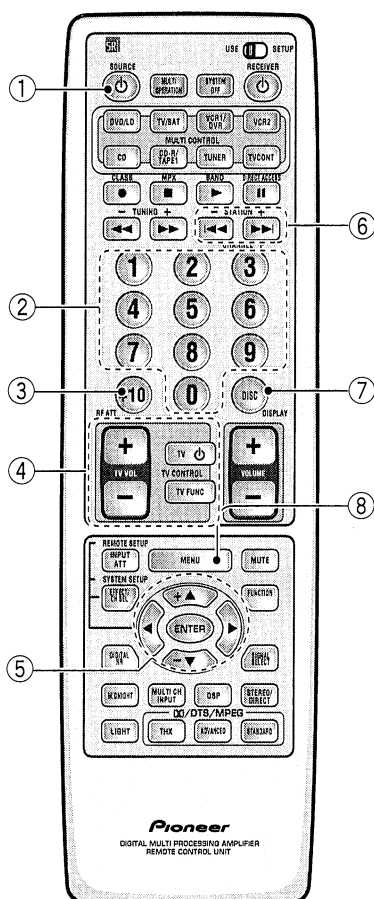

#### ① **⏻ SOURCE**

Press to switch the TV on or off (not possible with all models, especially those without a standby mode).

#### ② **Number buttons**

Use to select a specific TV channel.

#### ③ **+10**

Use to select a specific TV channel.

#### ④ **TV CONTROL buttons**

The following buttons are used to control the TV only and can be used no matter what function the remote control is set to.

**TV ⏻ button** – Press to turn the power of the TV on/off.

**TV FUNC button** – Press TV FUNC to select the TV for remote control operation.

**TV VOL +/- button** – Use to adjust the TV volume.

#### ⑤ **▲/▼/◀/▶/ENTER**

▲/▼/◀/▶/ : Press to select or adjust items on the menu screen.

**ENTER** : Press to activate the selected function.

#### ⑥ **CHANNEL +/-**

Use to select a TV channel.

#### ⑦ **DISC (CH ENTER)**

Use to select the channel specified with the number buttons (not all models require this step).

#### ⑧ **MENU**

Press to select the TV menu.

### Cassette Deck Operations

You can use this remote control to control most cassette decks, though with some models the functions may differ.

- The following operations are available from the receiver's remote control after you recall a cassette deck's preset code, but some operations may need to be learned by the receiver (see "Setting Up the Remote Control to Control Other Components," on pages 58 – 61).
- To perform these operations, press the CD-R/TAPE 1 button to set the remote to the TAPE operation mode.
- For more information on individual commands consult the manual that came with the component.

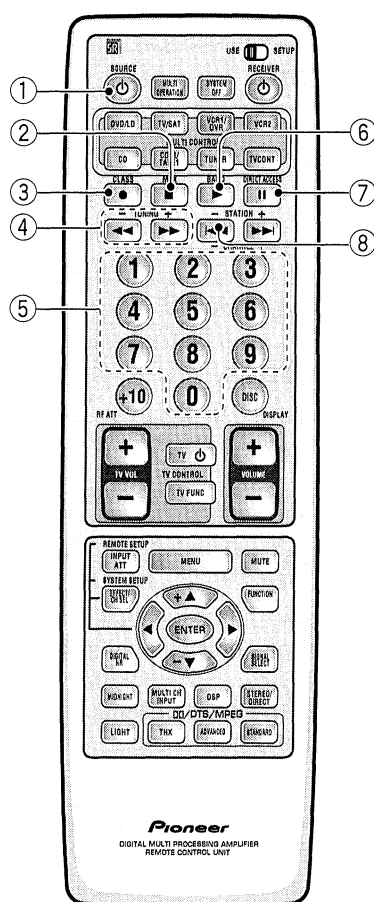

- ① **SOURCE**  
Press to switch the cassette deck on or off (not possible with all models, especially those without a standby mode).
- ② **■**  
Press to stop playback or recording.
- ③ **●**  
Press to start recording.
- ④ **◀◀/▶▶**  
◀◀: Press to rewind the tape.  
▶▶: Press to fast forward the tape.
- ⑤ **Number buttons (1-6)**  
1: **■** (Press to stop playback or recording.)  
2: **▶** (Press to start playback of the side of the cassette which has been loaded as the front.)  
3: **||** (Press to pause playback or recording.)  
4: **◀◀** (Press to rewind the tape.)  
5: **◀** (Press to start reverse playback.)  
6: **▶▶** (Press to fast forward the tape.)
- ⑥ **▶**  
Press to start playback of the side of the cassette which has been loaded as the front.
- ⑦ **||**  
Press to pause playback or recording.
- ⑧ **◀◀**  
Press to start reverse playback (for auto reverse decks).

# Using Other Functions

## Recording from Audio Components

The following explanations show you how to record an analog or digital audio signal. Note that your analog components cannot record a player that is only connected digitally (and vice-versa). If you want to record from a digital component to an analog one (for example, a tape deck), or vice-versa, the digital component it must be connected via analog jacks and you need to set the SIGNAL SELECT switch to ANALOG. To make exact digital copies (of digital sources like CDs) both the source component and the recorder must be connected with digital connections. See p.11 for more on analog audio connections and p.12 for digital audio connections.



The receiver's volume, channel level, balance, tone (BASS, TREBLE, and LOUDNESS), and surround effects have no effect on the recorded signal and the MULTI CHANNEL IN cannot be recorded. In some cases, digital recordings have copy guard protections and making a digital copy is not possible. In this case you can only copy them in an analog manner.

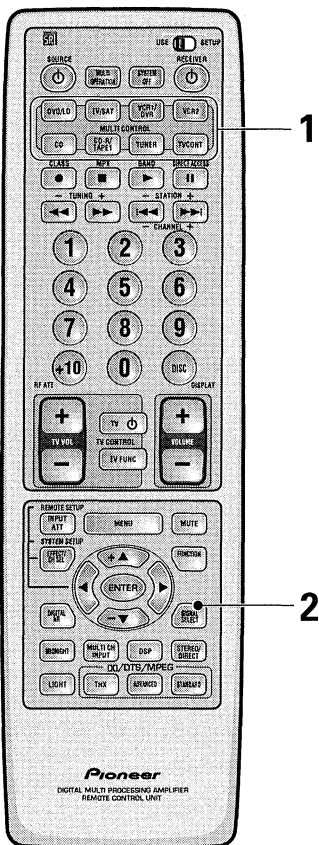

### 1 Select the source component.

### 2 Set the SIGNAL SELECT according to the source component's signal (ANALOG or DIGITAL).

Press the SIGNAL SELECT button on the remote control (or use the button on the front panel) and choose ANALOG.

### 3 Start recording with a recorder.

### 4 Playback the source to be recorded.

### Record monitor (TAPE 2 MONITOR)

If you connect a cassette deck with a record monitor function to the TAPE 2 MONITOR jacks, you can listen to the sound of an analog recording as it is being recorded.

Press TAPE 2 MONITOR to switch between the sound of the recording (TAPE 2 indicator on) and the sound of the source component (TAPE 2 indicator off).

TAPE 2 MONITOR

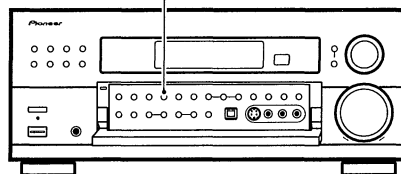

## Recording from Digital Audio Components

The following explanations show you how to record digital audio. Using this method you can make exact digital copies of sources like CDs or MDs. The only drawback is that you cannot switch between various recorders at the touch of a button like you can with analog recordings (see the previous page). If you look on the back of the receiver you will find a digital out jack which is marked PCM/DIG/DTS/MPEG OUT (it is to the right of the digital in jacks in the upper left-hand corner). If you connect this to the optical input on a digital recorder (currently these include MD, DAT, and CD-R), you can make direct digital recordings with this unit. Of course, the digital components you want to record, all need to be connected to the receiver with digital inputs as well. See p.12 if you have not made these connections.



The receiver's volume, channel level, tone (BASS, TREBLE, and LOUDNESS), and surround effects have no effect on the recorded signal.

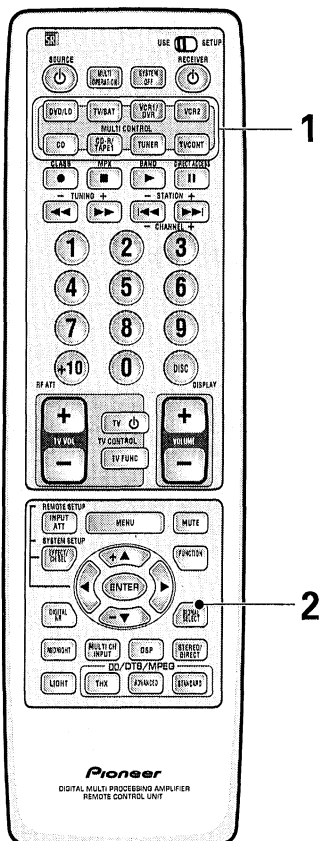

**1 Prepare the source you want to record and put the receiver in that function.**

**2 Set the SIGNAL SELECT to digital.**

Press the SIGNAL SELECT button on the remote control (or use the button on the front panel) and choose DIGITAL.

**3 Start recording with a CD-R or MD (etc.).**

**4 Play back the source to be recorded.**



In some cases, digital recordings have copy guard protections on them and making a digital copy is not possible. It is still possible to copy these digital sources if you have hooked the components up with analog connections (in this case, the copies will not be exact digital reproductions). Refer to the previous page in this case.

# Recording from Video Components

The following operations show you how to record audio and video to the video tape recorder connected to the VCR 1 or VCR 2 jacks. Note that all signals coming out of these jacks will be analog and it is not possible to record DTS soundtracks.

**memo** The receiver's volume, channel level tone (BASS, TREBLE, and LOUDNESS), and surround effects have no effect on the recorded signal.

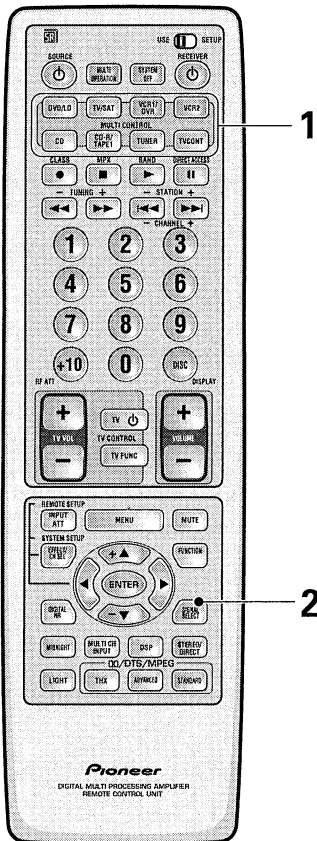

**1 First, decide the component you'd like to record and put the receiver in that function.**

**2 Set the SIGNAL SELECT to analog.**

Press the SIGNAL SELECT button on the remote control (or use the button on the front panel) and choose analog.

**3 Start recording with VCR 1 or VCR 2 (etc.).**

**4 Playback the source to be recorded.**

**memo** If the video material is copy protected you won't be able to copy it.



# Function Rename

Use the FUNCTION RENAME capability to rename the functions, like DVD/LD, CD, etc., in the display. You might want to do this in order to personalize the display on the receiver or if your components are different than the names preset in the receiver (for example if you connect a video camera to the VIDEO jacks on the front of the receiver). Follow the on screen displays on your TV or the display on the receiver to carry out this task. See pages 27– 28 for more instructions.

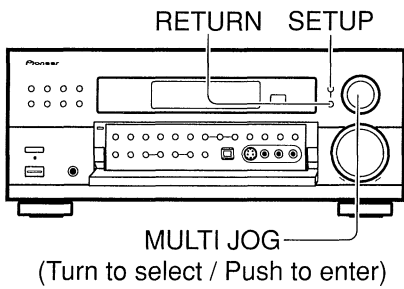

Set the remote control slide switch to SETUP

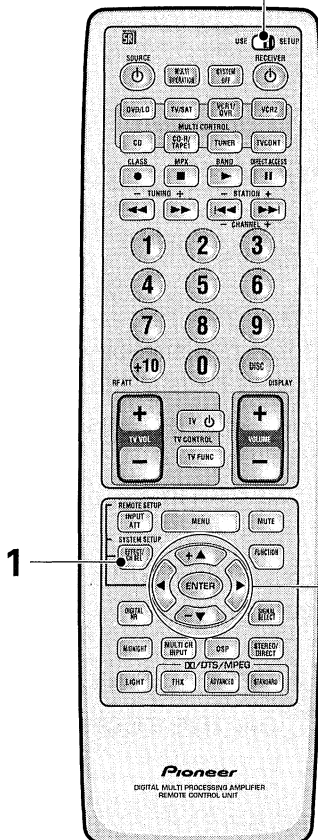

## 1 Press the SETUP button (SYSTEM SETUP button on the remote control).

You should see the following display on your TV.

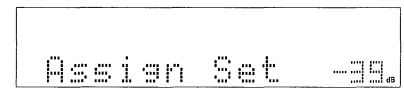
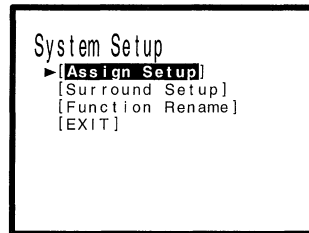

## 2 Use the MULTI JOG dial (▲/▼ buttons on the remote control) to select FUNCTION RENAME.



## 3 Press the MULTI JOG dial (ENTER on the remote control).

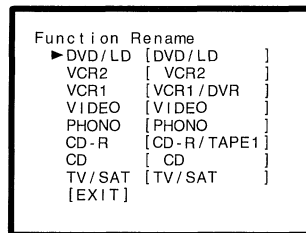

## 4 Use the MULTI JOG dial (▲/▼ buttons) to select the function that you want to rename.

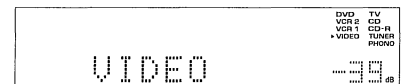

## 5 Press the MULTI JOG dial (press ENTER).

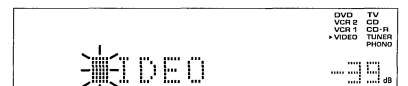
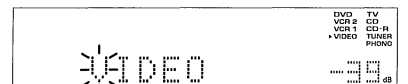
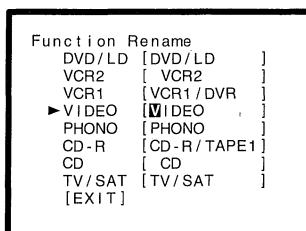

## Using Other Functions

Here are all the possible characters you can input:

ABCDEFGHIJKLMNOPQRSTUVWXYZ

abcdefghijklmnopqrstuvwxyz

0123456789

!"#\$%&'()\*+,-./:;<=>?\_

### 6 Use the MULTI JOG dial (▲/▼ buttons) to choose the first character.

The MULTI JOG dial scrolls through the letters, numbers and symbols you can input.



### Set the remote control slide switch to SETUP

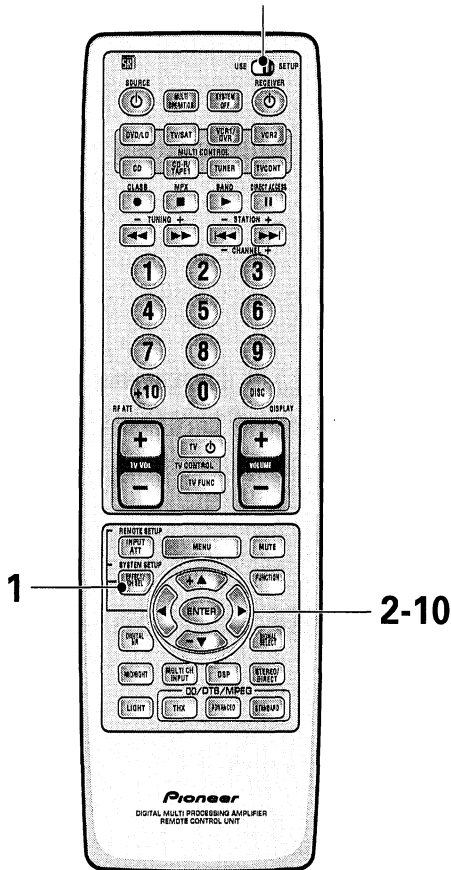

### 7 Press the MULTI JOG dial (press ENTER).

That character appears on the screen and the cursor automatically moves to the next space.

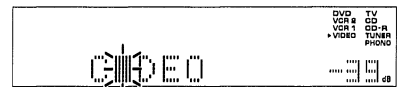
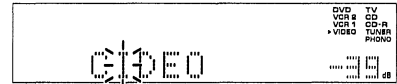
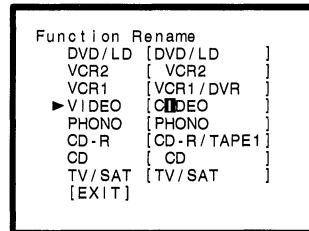

After ten characters have been entered, the character input mode is exited.

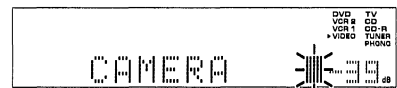

### 8 Repeat steps 4 to 7, spell out the function name you want to rename.

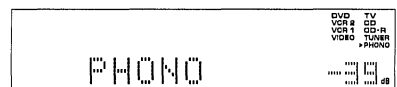
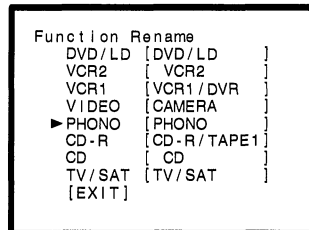

- You can include spaces, hyphens, most punctuation marks, other symbols and capital or lowercase letters in the name.
- When you want to change a function name, input the new function name using the same procedure.
- If you make a mistake you can use the RETURN button (◀ button) to go back a step.
- You can press the SETUP button (SYSTEM SETUP button on the remote control) to exit the process altogether.

### 9 Use the MULTI JOG dial (▲/▼ buttons) to select EXIT ("Rename End" on the receiver's display).

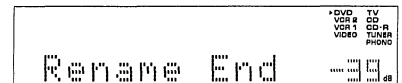

### 10 Press the MULTI JOG dial (press ENTER) twice.

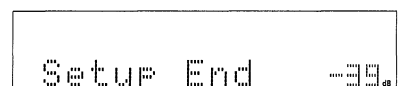

## Multi Operations

A Multi Operation is a sequence of commands programmed into a single button to save you a lot of repetitive button pressing. Once setup, pressing the MULTI OPERATION button followed by one of the MULTI CONTROL buttons will switch on that component, the receiver and your TV, and switch the function of the receiver to that component. Up to five more commands can be programmed into a Multi Operation, such as changing the sound mode of the receiver and starting playback of the source.

Important: For Multi Operations to work with other non-Pioneer components, you must first setup the remote to control those other components—see p. 58 – 61 for more on this.

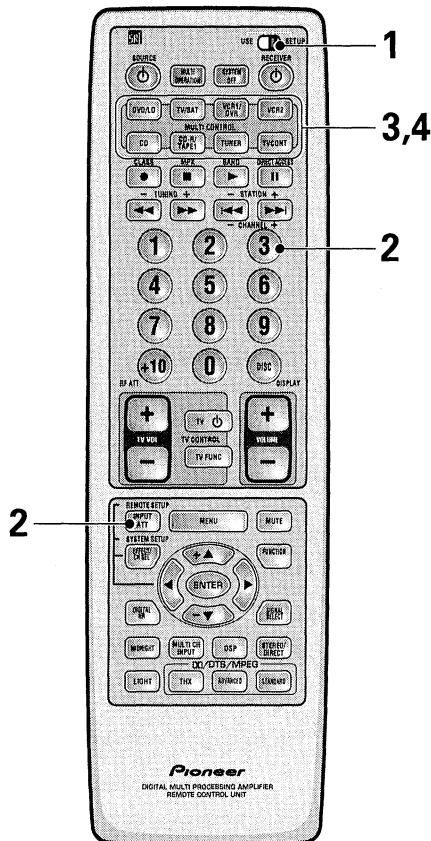

### 1 Set the remote control slide switch to **SETUP**.

Also make sure that your TV is on and set to the receiver.

### 2 Press the **REMOTE SETUP** button (**INPUT ATT**) and **3** at the same time to select the **MULTI OPERATION SETUP** mode.

The REMOTE SETUP menu appears on your TV screen. The MULTI CONTROL and the SYSTEM OFF buttons start to blink (see the following page for more on the SYSTEM OFF button).

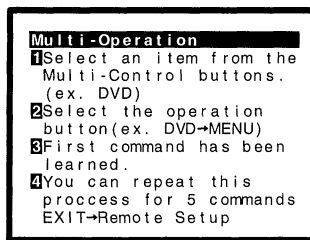

- To cancel here, press REMOTE SETUP.

### 3 Select a **MULTI CONTROL** button for this **MULTI OPERATION**.

Each MULTI CONTROL button can be used for one Multi Operation. If a Multi Operation relates to using a DVD player, for example, it makes sense to select the DVD/LD button.

After pressing a MULTI CONTROL button, just that button will remain blinking.

### 4 Select the **MULTI CONTROL** button for a **source component**.

For example, if you want this Multi Operation to switch on your DVD player and change the function of the receiver to DVD/LD, press the DVD/LD MULTI CONTROL.

After pressing a MULTI CONTROL button, that button stays lit.

## Using Other Functions

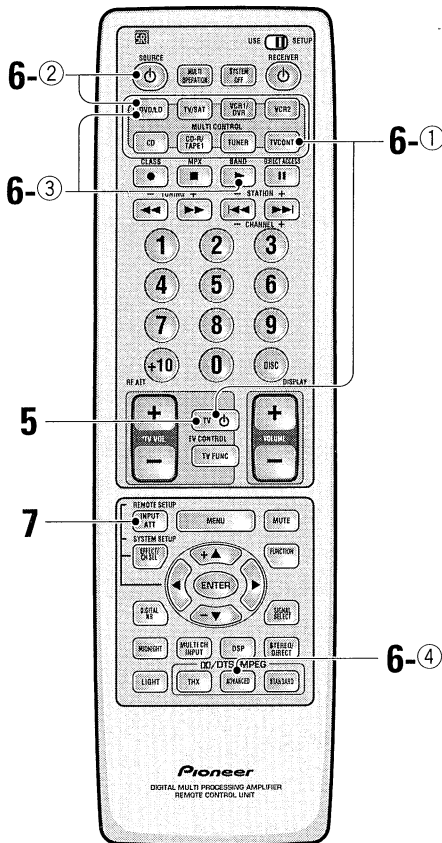

**5 Press the operation button, for example TV  $\phi$  (POWER), you want to input.**

**6 Repeat steps 4 and 5 to input MULTI OPERATIONS to the MULTI CONTROL button you pressed in step 3. You can also tell the receiver to go into a specific sound mode (THX, ADVANCED, STANDARD, MPEG, MIDNIGHT, DSP DNR, MULTI CH IN or STEREO) by inputting that command (for example, see operation 4 below).**

**You can repeat this process for up to five commands.**

**For example :** you could enter the following four operations using the preceding steps 4 and 5.

- ① Press the TV CONTROL button and TV  $\phi$  (POWER) to turn on your TV (as explained above).
- ② Press the DVD/LD button then  $\phi$  (POWER) to turn on your DVD player (if it is not a PIONEER product).
- ③ Press the DVD/LD button then  $\blacktriangleright$  (play) to start playing the DVD player.
- ④ Press the ADVANCED button to put the receiver in that sound mode.

When you employ MULTI OPERATIONS (see below), these four tasks will be performed in the same order.

**7 Press the REMOTE SETUP button to exit the Multi-operation setup mode.**

The remote control and TV return to their previous operation modes.



When you're done setting up, remember to set the slide switch back to USE.

## Performing Multi Operations

Once you've programmed a Multi Operation, here's how to use it.

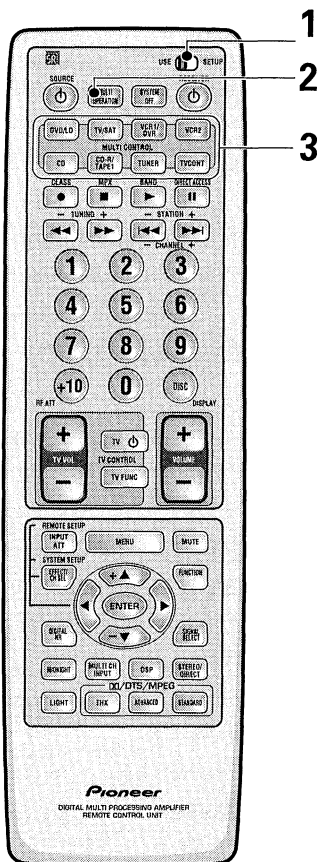

**1 Set the remote control slide switch to USE.**

**2 Press the MULTI OPERATION button on the remote control.**

The MULTI CONTROL buttons start to blink.

**3 Press the MULTI CONTROL button to activate that Multi Operation.**

The remote sends the Multi Operation commands you programmed.

## Erasing Multi Operations

The following operations allow you to erase the Multi operation settings stored in the remote control.

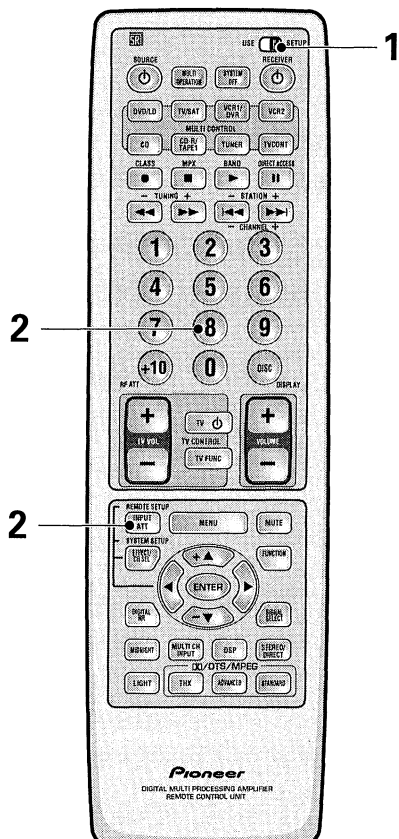

**1 Set the remote control slide switch to SETUP.**

**2 Press and hold both the REMOTE SETUP (INPUT ATT) button and 8 for more than 3 seconds.**

The MULTI CONTROL buttons will blink 3 times and all multi operation settings will be erased.

- When you're done erasing, remember to set the slide switch back to USE.

# System Off

The SYSTEM OFF feature allows you to tell the receiver and your other components to stop and turn off with the push of only one button on the remote control. For example, you can program the unit to stop your DVD, turn off your TV, turn off your DVD player and turn off the receiver itself. You don't need to program in other the power for PIONEER components, they will go off automatically in this mode. The receiver itself will go off automatically as well.

The steps below show you how to program a string of up to 5 different SYSTEM OFF operations based on eight possible components.



Be sure to recall or teach the remote control commands for each component before attempting MULTI OPERATIONS (see "Setting Up the Remote Control to Control Other Components," page 58 – 61).

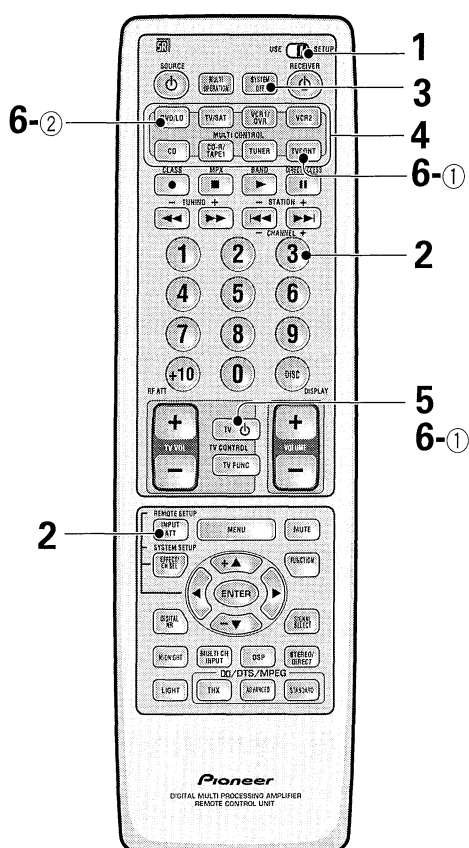

### 1 Set the remote control slide switch to **SETUP**.

Also make sure that your TV is on and set to the receiver.

### 2 Press the **REMOTE SETUP (INPUT ATT)** button and **3** at the same time to select the **MULTI OPERATION SETUP** mode.

The REMOTE SETUP menu appears on your TV screen. The MULTI CONTROL and the SYSTEM OFF buttons start to blink.

To cancel MULTI OPERATION SETUP mode, press REMOTE SETUP.

### 3 Press the **SYSTEM OFF** button.

The SYSTEM OFF button will blink.

### 4 Press the **MULTI CONTROL** button for the component whose operation you want to start SYSTEM OFF with (for example, TV CONT button).

The selected button will light steadily.

### 5 Press the operation, for example TV $\odot$ (POWER), you want to input.

### 6 Repeat steps 4 and 5 to input SYSTEM OFF for the components and commands you want to input.

**You can repeat this process for up to five commands.**

For example : you could enter the following two operations using the proceeding steps 3 and 4.

- ① Press TV CONT button & TV  $\odot$  (POWER) to turn off your TV (as explained above).
- ② Press DVD/LD then  $\odot$  (POWER) to turn off your DVD player (if it is not a PIONEER product).

- To exit SYSTEM OFF SETUP mode, press REMOTE SETUP.
- When you're done inputting the settings remember to set the slide switch back to USE.

## Using the System Off button

This button will turn off the receiver and any component that has programmed into the SYSTEM OFF settings (see above) as well as turn off all PIONEER components regardless of whether they have been programmed into SYSTEM OFF. If you use this feature when a DVD is playing, the player will stop the play mode before switching off.

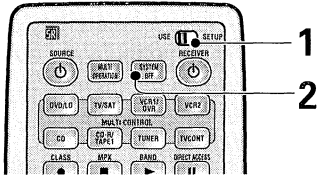

- 1 Set the remote control slide switch to USE.**
- 2 Press the SYSTEM OFF button on the remote control.**

## Direct Function

The DIRECT FUNCTION is designed in case you have an external video source connected to your TV (a video source that is not going through the receiver). For this explanation we'll call this the "external video deck." You'd like to control the external video deck with this unit's remote control so you've assigned it a function button (for example purposes, the VCR 2 button). Yet, if you put the receiver in VCR 2 mode you'll get no picture on your TV because the external video deck signal is not going through the receiver. To get around this problem you set the DIRECT FUNCTION for VCR 2 to OFF. Now when you press VCR 2 function button you can control the external video deck with the remote but the receiver does not go into VCR 2 mode.

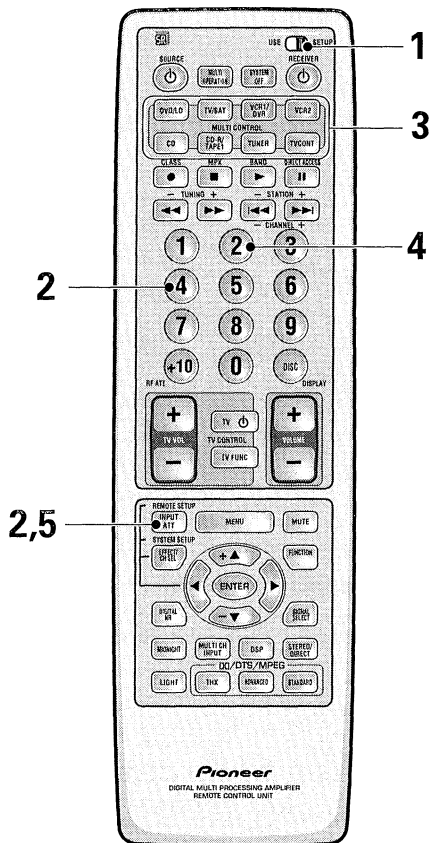

- 1 Set the remote control slide switch to SETUP.**

Also make sure that your TV is on and set to the receiver.

- 2 Press the REMOTE SETUP (INPUT ATT) button and (4) at the same time to select the DIRECT FUNCTION mode.**

The MULTI CONTROL buttons DVD/LD, TV/SAT, VCR 1/DVR, VCR 2, CD, and CD-R/TAPE 1 start to blink.

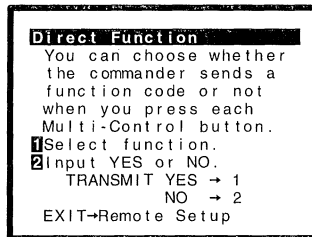

- 3 Select a component by pressing its MULTI CONTROL button.**
- 4 Set the DIRECT FUNCTION of each external source to NO by pressing (2).**
- 5 Press the REMOTE SETUP button to exit the DIRECT FUNCTION mode.**
  - When you're done changing the setting remember to set the slide switch back to USE.



The default setting for all functions is YES. If you have turned a DIRECT FUNCTION to NO and want to turn it back to YES, follow the directions above and press (1) in step 4.

# Remote Back Light

When you press any button on the remote all the buttons light for a few seconds. You can change the strength of this light here. MAX is the strongest. MID is slightly weaker. There's also the option to switch off backlighting altogether. This extends battery life considerably.

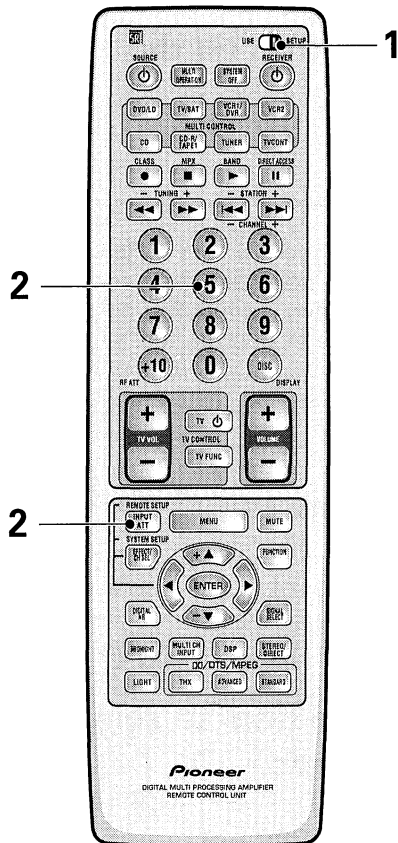

**1 Set the remote control slide switch to SETUP.**

**2 Press and hold both the REMOTE SETUP (INPUT ATT) button and 5.**

The remote back light options cycle in the following order:

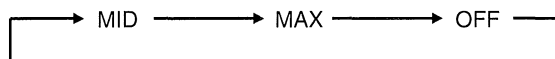

The default setting is MID.

- When you're done changing the setting remember to set the slide switch back to USE.

# Changing the Display

You can change the display on the front panel between the function and the sound mode by pressing the MULTI JOG dial (see #16 on p. 22).

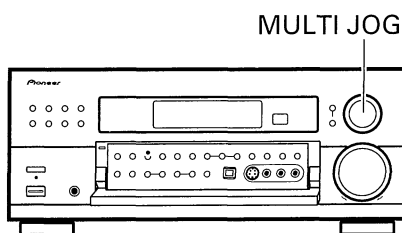

**Press the MULTI JOG dial on the front panel to move between the function (DVD/LD, CD, etc.) display and the sound mode (STEREO, ETC.) display.**

The display will remain on the setting you choose. If you turn the MULTI JOG dial to select a new function, the function is displayed.



## Video Select

This function allows you to listen to one sound source while you watch a different video source on your TV. The sound source is set in the normal fashion as is explained on p. 45 & 46. You then alter the video input with the VIDEO SELECT button.

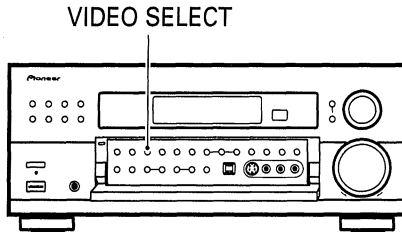

### Press the VIDEO SELECT button on the front panel to cycle through the different possible video inputs.

The first press shows the video input you are currently using. After that pressing VIDEO SELECT cycles through the possibilities in the following order:

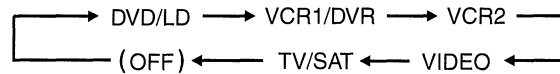

The OFF setting means that no video signal is output.

After choosing a video input the display on the receiver will show that input for about 5 seconds and then revert to showing the sound mode the receiver is in.

### The VIDEO SELECT remains set to the input you chose until you change the audio input.

If you change audio functions the receiver will reset itself to make the video and audio inputs correspond.

Also, if you switch the power of the receiver OFF when you turn it back on the video and audio inputs will reset so that they correspond.

# Techno Tidbits & Problem-solving

## Dolby Digital



Dolby Digital is a compression format which records the sound of 6 channels of the theater surround system (Dolby Digital) on the movie film digital track. Of the 6 channels, the subwoofer channel is intended for bass only, and because the frequency range is smaller than the main channel, it is expressed as 5.1 channel.

Dolby Digital is the name of the Dolby surround multi-channel digital system that was developed after the Dolby Surround System and Dolby Pro Logic Surround System.

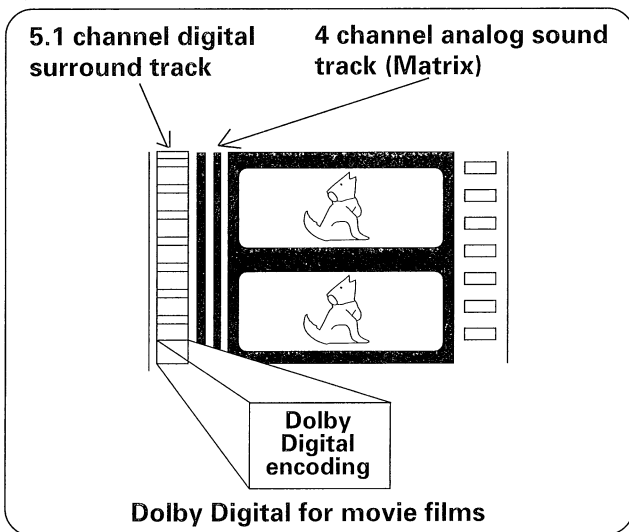

The number of movies made using Dolby Digital since 1992 has exceeded 300 and continues to increase. For compact disc players and laser disc digital sounds, 16 bits are used to sample the original analog audio waveform and sampling is carried out 44,100 times every second. However because an enormous amount of recording signal data is required for the multi channel system with this method, Dolby Digital is used to compress the data.

In reproducing audio signals, the smaller the bit number used, the lower the sound quality. With Dolby Digital, drop in auditory sound quality is prevented by using masking technology and digital filtering technology based on the human auditory characteristics.

## Laser disc format

Laser discs are now available on the market in large numbers. This means that the recording of different format audio signals on the laser disc raises the important question of compatibility with existing laser discs. Dolby Digital tracks on laser discs record signals using the space of one analog audio channel so it will maintain compatibility with existing discs and players.

As shown in the following figure, the digital audio sounds of Dolby Digital discs can be played back as currently done. Analog sounds are played back by using the other channel without the Dolby Digital signals for monaural audio signals.

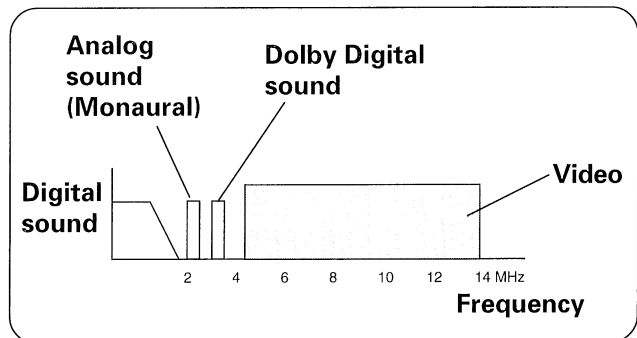

## DTS



DTS has been adopted as a sound recording format in the latest movie theaters since the release of "JURASSIC PARK" in 1993, and has a good reputation for high quality sound and dynamic surround effects.

In this system, 6 channels of digital sound are recorded on CD-ROM, rather than on the film. DTS adopts a simultaneous playback format. With a low rate of compression of sound signals and a high rate of transmittance, a higher sound quality format is produced. Also, unlike the process of recording digital sounds on film directly, the only components required are a CD-ROM player as might be used with a personal computer and a DTS processor, and therefore less investment is required than with other formats. For this reason, the format is being introduced in more and more movie theaters, and is being adopted in home movie software (DVD, LD) and music software (5.1 channel CD). DTS has recently added a third surround channel to its system. This has come to be known as DTS Extended Surround or simply DTS-ES.





THX is a Lucasfilm, Ltd. program dedicated to maximum accuracy in movie presentation. Movie sound tracks are recorded in large movie dubbing stages using movie theater equipment. For a sound track to be presented accurately in your home, special technologies are required. In your home the room is much smaller and has a bright sound, the speakers are very different and there are only six-eight of them, plus, you sit much closer to each one of those speakers. Because of these differences we often miss the power and emotion that thrills us in a good movie. Now Pioneer and THX have teamed up to bring the full glory of accurate cinema sound to the comfort and convenience of your home.

**Re-Equalization™** : In a theater the room is very large and dead sounding, you sit a long way back from the speakers and the speakers themselves are very specialized. Because a sound track recorded in this dead sounding space when it is played at home it sounds overbright. THX Re-Equalization adjusts for this difference in a very precise way.

**Adaptive Decorrelation™** : When a sound track sends mono sound to the surround speakers it often seems to be coming from one side instead of from all around you as it would in a theater. Adaptive Decorrelation helps to correct this inaccuracy.

**Timbre Matching™** : When recording a sound track it is very important that the surround sounds move smoothly and seamlessly around the theater. It is very distracting when sounds seem to jump from speaker to speaker. Timbre Matching helps to smooth the movement of the surround sounds even though you are using only two speakers.

**Bass Peak Level Manager™** : Some Dolby Digital sound tracks can produce bass peaks that are undesirable in a home theater environment. The Bass Peak Level Manager allows you to set the maximum peak levels appropriate to your system. (Set this function according to the **Bass Peak Level** instructions on page 39.)

**Loudspeaker Position Time Synchronization™** : This feature allows you to adjust for the difference in the distance from each individual loudspeaker to the listening position. Doing this ensures that all the speakers operate in precise synchronization improving the seamless nature of the soundfield. (Set this function according to the **Channel Delay** instructions on p. 35.)

**THX Surround EX™** : THX Surround EX–Dolby Digital Surround EX is a joint development of Dolby Laboratories and the THX division of Lucasfilm Ltd.

In a movie theater, film soundtracks that have been encoded with Dolby Digital Surround EX technology are able to reproduce an extra channel which has been added during the mixing of the program. This channel, called Surround Back, places sounds behind the listener in addition to the currently available front left, front center, front right, surround right, surround left and subwoofer channels. This additional channel provides the opportunity for more detailed imaging behind the listener and brings more depth, spacious ambience and sound localization than ever before.

Movies that were created using the Dolby Digital Surround EX technology, when released into the home consumer market may exhibit a Dolby Digital Surround EX logo on the packaging. A list of movies created using this technology can be found on the Dolby web site at <http://www.dolby.com>.

Only receiver and controller products bearing the THX Surround EX logo, when in the THX Surround EX mode, faithfully reproduce this new technology in the home.

This product may also engage the "THX Surround EX" mode during the playback of 5.1 channel material that is not Dolby Digital Surround EX encoded. In such case the information delivered to the Surround Back channel will be program dependent and may or may not be very pleasing depending on the particular soundtrack and the tastes of the individual listener.

## MPEG Audio

MPEG is an audio encoding system which delivers high quality audio for music and movies. By removing frequencies which are out of the human hearing range, the sound is then compressed to enable the transmission of mono, stereo, or multichannel (5.1 and 7.1) audio in a single bitstream which is why it has become a standard audio format for DVD and personal computers. The composition and versatility of MPEG audio also ensures that the presentation of a multichannel soundtrack will sound appropriate on everything from a 7.1 channel surround sound home theater setup to a mono television set. Above all, MPEG audio is designed to be compatible with past and future MPEG audio versions, which means that future versions of MPEG audio will be compatible with decoders currently being produced (the signal is merely reconfigured to fit the number of channels available in a system).

### STATION CALL table

We recommend you make a note of your preset stations.

CLASS A	Station No.	*1	*2	*3	*4	*5
	Station Name					
	Frequency					
	Station No.	*6	*7	*8	*9	*0
	Station Name					
	Frequency					
CLASS B	Station No.	*1	*2	*3	*4	*5
	Station Name					
	Frequency					
	Station No.	*6	*7	*8	*9	*0
	Station Name					
	Frequency					
CLASS C	Station No.	*1	*2	*3	*4	*5
	Station Name					
	Frequency					
	Station No.	*6	*7	*8	*9	*0
	Station Name					
	Frequency					

# Preset Code List

## DVD PLAYER & DVD RECORDER

Manufacturer	Code
TOSHIBA	001
SONY	002
PANASONIC	003
JVC	004
SAMSUNG	005
SHARP	006
AKAI	007
RCA	009
PIONEER	000, 008, 456(DVR)

## LD PLAYER

Manufacturer	Code
DENON	110
HITACHI	109
PHILIPS	104, 108
RADIOLA	108
SONY	101, 102
TELEFUNKEN	100
PANASONIC	105, 106
KENWOOD	103
mitsubishi	100
RCA	107
PIONEER	100,111

## STB (SAT)

Manufacturer	Code
RCA	201, 203
SONY	202
ECHOSTAR	205
PIONEER	200, 204, 207

## STB (CATV)

Manufacturer	Code
JERROLD	209, 210, 211, 212, 219, 220, 221, 222, 223, 224
S.ATLANTA	213, 214, 216, 217
ZENITH	215, 225, 218
PIONEER	208

## STB (DTV)

Manufacturer	Code
PIONEER	207

## VCR

Manufacturer	Code
PHILIPS	414, 428
PANASONIC	432, 433, 408
THOMSON	417, 449, 428
SONY	404, 408, 416, 417, 457, 458, 459
JVC	407, 408, 414, 417, 428, 429, 430, 431
GRUNDIG	408, 414, 441, 453, 454, 455
AKAI	442, 417

Manufacturer	Code
HITACHI	401, 406, 408, 417, 434, 436, 441
TOSHIBA	405, 409, 414, 417, 426, 428
MITSUBISHI	407, 408, 409, 414, 420, 421, 422, 423, 424
SHARP	402, 418, 419
ORION	445, 446, 424
SANYO	410, 412, 425, 435, 444
FERGUSON	417, 449, 450
BLAUPUNKT	432, 408, 417, 455
NOKIA	442, 444, 417
SELECO	417
AIWA	446, 441
AKIBA	453
ALBA	446, 447, 448, 452, 424
AMBASSADOR	452
AMSTRAD	441
ANITECH	453
ASA	411, 414
BAIRD	444, 417, 441, 450
BASIC LINE	448, 452, 453
BRANDT	449, 451
BRANDT ELECTRONIQUE	417
BUSH	446, 447, 448, 424, 453
CATRON	452
CGB	441
CIMLINE	453
CLATRONIC	452
CONDOR	452
CROWN	448, 452, 453
DAEWOO	448, 452
DANSAI	453
DE GRAAF	406
DECCA	414, 441
DUAL	417
DUMONT	444, 414, 441
ELCATECH	453
FIDELITY	441
FINLANDIA	444, 414
FINLUX	406, 444, 414, 441
FIRSTLINE	405, 409, 411, 424, 453
FISHER	410, 412, 420, 425, 426, 427, 444
FRONTECH	452
FUNAI	441
GBC	414
GENERAL	452
GOLDSTAR	409, 411
GOODMANS	411, 448, 441, 452, 453
GRAETZ	444, 417
GRANADA	444, 414
GRANDIENTE	441
GRANDIN	411, 441, 453
HCM	453, 454

Manufacturer	Code
HINARI	445, 446, 453, 454
HYPSON	453
IMPERIAL	441
INTERFUNK	414
ITT	442, 444, 417, 428
ITV	411, 448
KAISUI	453
KENDO	444, 424
KORPEL	453
LEYCO	453
LOEWE	411, 414
LUXOR	442, 409, 444
M-ELECTRONIC	441
MAGNAVOX	403, 408, 414, 426
MANESTH	405, 453
MARANTZ	414
MATSUI	445, 446, 424
MEMOREX	444, 411, 441
MEMPHIS	453
METZ	432, 455
MINERVA	455
MULTITECH	441, 453
MURPHY	441
NBC	407, 417
NECKERMANN	414
NESSCO	453
NORDMENDE	417, 428
OCEANIC	417, 441
OPTIMUS	402, 408, 418, 419, 432, 433
OSAKI	411, 441, 453
OTTO VERSAND	414
PALLADIUM	411, 417, 453
PATHE MARCONI	417
PENTAX	406
PERDIO	441
PHONOLA	414
PORTLAND	452
PROLINE	441, 454
PYE	414
QUELLE	414
RADIOLA	414
RCA	401, 405, 406, 408, 411, 413, 414, 415
REX	417, 428
ROADSTAR	411, 448, 453
SABA	417, 449, 428
SAISHO	445, 424
SALORA	442, 409
SANSUI	407, 417
SBR	414
SCHAUB LORENZ	417, 441
SCHNEIDER	414, 441, 453
SEI	414
SENTRA	452
SHINTOM	453
SIEMENS	444, 411, 455
SINGER	405
SINUDYNE	414
SOLAVOX	452
SUNSTAR	441
SUNTRONIC	441

## Techno Tidbits & Problem-solving

Manufacturer	Code
TASHIKO	441
TATUNG	414, 417, 441
TEC	452
TELEAVIA	417
TELEFUNKEN	417, 449, 451, 428
TENOSAL	453
TENSAI	441
THORN	444, 417
UNIVERSUM	442, 411, 414, 441, 455
YAMISHI	453
YOKAN	453
YOKO	452
ZENITH	403, 404, 417
PIONEER	400, 443, 407, 414, 456(DVR)

### TAPE DECK

Manufacturer	Code
AKAI	829
ARCAM	810
DENON	810, 827
FISHER	813
GRUNDIG	821
JVC	802
KENWOOD	804, 807, 822
LUXMAN	815
MARANTZ	821
MEMOREX	825
MITSUBISHI	829
NAKAMICHI	816
ONKYO	808, 809, 817, 819
OPTIMUS	800
PHILIPS	821
SANSUI	824
SHERWOOD	818
SONY	801, 806, 814, 823
TANDBERG	820
TEAC	805
TECHNICS	803
TOSHIBA	826, 828
YAMAHA	811, 822
PIONEER	800, 825

### CD PLAYER

Manufacturer	Code
AKAI	335
ARCAM	336
ASUKA	337
AUDIO TON	336
BUSH	332
CALIFORNIA AUDIO LAB	304
CYRUS	336
DENON	309
DUAL	337, 319
FISHER	340
GOLDSTAR	330
GRUNDIG	336
HITACHI	334
INTERSOUND	337
JVC	303, 331
KENWOOD	310, 311, 321
KODAK	322
LINN	336

Manufacturer	Code
LUXMAN	341
M ELECTRONIC	344
MARANTZ	304, 312, 323, 324, 336
MATSUI	336
MCS	304
MEMOREX	300
MERIDIAN	336
MITSUBISHI	335
NAD	316
NAIM	336
ONKYO	307, 308, 320, 342
OPTIMUS	300
PANASONIC	304
PHILIPS	312, 322, 336
QUAD	336
QUASER	304
RCA	302, 313, 319
ROADSTAR	344
ROTEL	336
SABA	319
SANYO	313, 340
SHARP	343
SONY	301, 316, 317, 318, 329
TEAC	305, 306, 324, 325, 327
TECHNICS	304, 326, 333
TELEFUNKEN	319
THOMSON	319
UNIVERSUM	336
YAMAHA	314, 315, 328, 338, 339
PIONEER	300

### CD RECORDER

Manufacturer	Code
PHILIPS	346
PIONEER	345

### TV

Manufacturer	Code
PHILIPS	631, 607, 634, 656
SONY	604
GRUNDIG	631, 653
PANASONIC	607, 608, 631, 642, 622
TOSHIBA	602, 605, 621, 626, 653
TELEFUNKEN	636, 637, 652
SHARP	602, 619, 627
SAMSUNG	607, 638, 644, 646
HITACHI	606, 610, 618, 624, 625, 631, 633, 634, 636, 642, 643, 654
SABA	631, 636, 642, 651
BRANDT	636
SANYO	614, 621, 635, 645, 648
THOMSON	636, 651, 652
FERGUSON	607, 636, 651
NOKIA	632, 642, 652

Manufacturer	Code
MITSUBISHI	602, 609, 610, 621, 631
SCHNEIDER	607, 641, 647
GOLDSTAR	602, 607, 610, 621, 623, 650
BLAUPUNKT	631
NORDMENDE	632, 636, 651, 652
RADIOLA	607
JVC	613, 623
DAEWOO	607, 644, 656
ORION	632, 607, 639, 640
SIEMENS	631
ACURA	644
ADMIRAL	631
AKAI	632, 635, 642
AKURA	641
ALBA	607, 639, 641, 644
AMSTRAD	642, 644, 647
ANITECH	644
ASA	645
ASUKA	641
AUDIOGONIC	607, 636
BASIC LINE	641, 644
BAUR	631, 607, 642
BEKO	638
BEON	607
BLUE SKY	641
BLUE STAR	618
BPL	618
BTC	641
BUSH	607, 641, 642, 644, 647, 656
CASCADE	644
CATHAY	607
CENTURION	607
CGB	642
CIMLINE	644
CLARIVOX	607
CLATRONIC	638
CONDOR	638
CONTEC	644
CROSLEY	632
CROWN	638, 644
CRYSTAL	642
CYBERTRON	641
DAINICHI	641
DANSAI	607
DAYTON	644
DECCA	607, 648
DIXI	607, 644
DUMONT	653
ELIN	607
ELITE	641
ELTA	644
EMERSON	642
ERRES	607
FINLANDIA	635, 643, 655
FINLUX	632, 607, 645, 648, 653, 654, 655
FIRSTLINE	640, 644
FISHER	632, 635, 638, 645
FORMENTI	632, 607, 642

<b>Manufacturer</b>	<b>Code</b>
FRONTECH	631, 642, 646
FRONTECH/PROTECH	632
FUJITSU	648
FUNAI	640, 646, 658
GBC	632, 642
GE	601, 602, 607, 608, 610, 617, 618, 628
GEC	607, 634, 648
GELOSO	632, 644
GENEXXA	631, 641
GOODMANS	607, 639, 647, 648, 656
GORENJE	638
GPM	641
GRAETZ	631, 642
GRANADA	607, 635, 642, 643, 648
GRANDIENTE	630, 657
GRANDIN	618
HANSEATIC	607, 642
HCM	618, 644
HINARI	607, 641, 644
HISAWA	618
HUANYU	656
HYPSON	607, 618, 646
ICE	646, 647
IMPERIAL	638, 642
INDIANA	607
INGELEN	631
INTERFUNK	631, 632, 607, 642
INTERVISION	646, 649
ISUKAI	641
ITC	642
ITT	631, 632, 642
JEC	605
KAISUI	618, 641, 644
KAPSCH	631
KENDO	642
KENNEDY	632, 642
KORPEL	607
KOYODA	644
LEYCO	607, 640, 646, 648
LIESENK&TTER	607
LUXOR	632, 642, 643
M ELECTRONIC	631, 644, 645, 654, 655, 656
M-ELECTRONIC	607, 636, 651
MAGNADYNE	632, 649
MAGNAFON	649
MAGNAVOX	603, 607, 610, 612, 629
MANESTH	639, 646
MARANTZ	607
MARK	607
MATSUI	607, 639, 640, 642, 644, 647, 648
MCMICHAEL	634
MEDIATOR	607
MEMOREX	644
METZ	631
MINERVA	631, 653
MULTITECH	644, 649
NECKERMANN	631, 607
NEI	607, 642

<b>Manufacturer</b>	<b>Code</b>
NIKKAI	605, 607, 641, 646, 648
NOBLIKO	649
OCEANIC	631, 632, 642
OSAKI	641, 646, 648
OSO	641
OSUME	648
OTTO VERSAND	631, 632, 607, 642
PALLADIUM	638
PANAMA	646
PATHO CINEMA	642
PAUSA	644
PHILCO	632, 642
PHOENIX	632
PHONOLA	607
PROFEX	642, 644
PROTECH	607, 642, 644, 646, 649
RADIO SHACK	602, 610, 621, 623
QUELLE	631, 632, 607, 642, 645, 653
R-LINE	607
RCA	601, 610, 615, 616, 617, 618
RBM	653
REDIFFUSION	632, 642
REX	631, 646
ROADSTAR	641, 644, 646
SAISHO	639, 644, 646
SALORA	631, 632, 642, 643
SAMBERS	649
SBR	607, 634
SCHAUB LORENZ	642
SEG	642, 646
SEI	632, 640, 649
SELECO	631, 642
SIAREM	632, 649
SINUDYNE	632, 639, 640, 649
SKANTIC	643
SOLAVOX	631
SONOKO	607, 644
SONOLOR	631, 635
SONTEC	607
SOUNDWAVE	607
STANDARD	641, 644
STERN	631
SUSUMU	641
SYSLINE	607
TANDY	631, 641, 648
TASHIKO	634
TATUNG	607, 648
TEC	642
TELEAVIA	636
TELETECH	644
TENSAI	640, 641
THORN	631, 607, 642, 645, 648
TOMASHI	618
TOWADA	642
ULTRAVOX	632, 642, 649
UNIVERSUM	631, 607, 638, 642, 645, 646, 654, 655
VESTEL	607

VOXSON	631
WALTHAM	643
WATSON	607
WATT RADIO	632, 642, 649
WHITE WESTINGHOUSE	607
YOKO	607, 642, 646
ZENITH	603, 620
PIONEER	600, 672, 631, 632, 607, 636, 642, 651

### MD RECORDER & DAT

<b>Manufacturer</b>	<b>Code</b>
SONY	901
KENWOOD	903
SHARP	902
TEAC	904
ONKYO	905
DENON	906
PIONEER	900, 902, 907(DAT)

### TUNER

<b>Manufacturer</b>	<b>Code</b>
PIONEER	500

# Troubleshooting

Incorrect operations are often mistaken for trouble and malfunctions. If you think that there is something wrong with this component, check the points below. Sometimes the trouble may lie in another component. Investigate the other components and electrical appliances being used. If the trouble cannot be rectified even after exercising the checks listed below, ask your nearest PIONEER authorized service center or your dealer to carry out repair work.

Symptom	Cause	Remedy
The power does not turn ON.	<ul style="list-style-type: none"> <li>The power plug is disconnected.</li> <li>The protection circuit may have been activated.</li> </ul>	<ul style="list-style-type: none"> <li>Connect the power plug to the wall outlet.</li> <li>Plug in again. If it still doesn't work call a service center.</li> </ul>
The unit does not respond when the buttons are pressed.	<ul style="list-style-type: none"> <li>Static electricity caused by dry air.</li> </ul>	<ul style="list-style-type: none"> <li>Disconnect the power plug from the outlet, and insert again.</li> </ul>
No sound is output when a function is selected.	<ul style="list-style-type: none"> <li>Improper connections.</li> <li>Sound is muted.</li> <li>The volume is turned down.</li> <li>The TAPE 2 MONITOR is ON.</li> <li>Speakers are turned OFF.</li> <li>DIGITAL/ANALOG switch is set incorrectly.</li> </ul>	<ul style="list-style-type: none"> <li>Make sure the component is connected correctly (see p. 11 – 20).</li> <li>Press MUTE on the remote control.</li> <li>Adjust MASTER VOLUME.</li> <li>Press the TAPE 2 MONITOR button.</li> <li>Press SPEAKERS (A/B) to select the speakers you connected.</li> <li>Set SIGNAL SELECT (see p. 47)</li> </ul>
No image is output when a function is selected.	<ul style="list-style-type: none"> <li>Improper connections.</li> <li>The input source is not properly selected.</li> </ul>	<ul style="list-style-type: none"> <li>Make sure the component is connected correctly (see p. 11 – 16).</li> <li>Press the correct function button.</li> </ul>
Considerable noise in radio broadcasts.	<ul style="list-style-type: none"> <li>Incorrect frequency.</li> <li>The antenna is not connected.</li> <li>RF and/or digital cables are near the antenna terminals and wires.</li> </ul>	<ul style="list-style-type: none"> <li>Tune in the correct frequency.</li> <li>Connect the antenna (see p. 17).</li> <li>Route RF and digital cables away from the antenna terminals and wires.</li> </ul>
	<p><b>FM broadcasts</b></p> <ul style="list-style-type: none"> <li>The FM antenna is not fully extended or is poorly positioned.</li> <li>Weak radio signals.</li> </ul>	<ul style="list-style-type: none"> <li>Fully extend the FM wire antenna, position for best reception, and secure to a wall.</li> <li>Connect an outdoor FM antenna (see p. 17).</li> </ul>
	<p><b>AM broadcasts</b></p> <ul style="list-style-type: none"> <li>The AM antenna is poorly positioned.</li> <li>Weak radio signals.</li> <li>Interference caused by other equipment (fluorescent lamp, motor, etc.)</li> </ul>	<ul style="list-style-type: none"> <li>Adjust the direction and position for best reception.</li> <li>Connect an additional internal or external AM antenna (see p. 17).</li> <li>Turn off the equipment causing the noise or move it away from the receiver.</li> <li>Place the antenna farther away from the equipment causing the noise.</li> </ul>
Broadcast stations cannot be selected automatically.	<ul style="list-style-type: none"> <li>Weak radio signals.</li> </ul>	<ul style="list-style-type: none"> <li>Connect an outdoor antenna (see p. 17).</li> </ul>
Subwoofer output is very low.	<ul style="list-style-type: none"> <li>Settings route signal away from Sub woofer</li> </ul>	<ul style="list-style-type: none"> <li>To get more signal to the subwoofer set it to PLUS or choose SMALL for the FRONT speakers (see p. 33 – 34).</li> </ul>
When playing an LD the SIGNAL SELECT is on RF but there is still no sound.	<ul style="list-style-type: none"> <li>The LD is not a Dolby Digital compatible disc.</li> </ul>	<ul style="list-style-type: none"> <li>Set the SIGNAL SELECT to analog (make sure your LD player is hooked up with analog connections in addition to digital and RF connections, see p. 13).</li> </ul>
When playing a DTS source the 5.1 Channel indicator doesn't light	<ul style="list-style-type: none"> <li>The DTS source is not 5 channels.</li> </ul>	<ul style="list-style-type: none"> <li>There is no problem with the receiver but if you want 5 channel sound you must play a 5 channel source.</li> </ul>
No sound from surround or center speakers.	<ul style="list-style-type: none"> <li>Speaker settings are incorrect.</li> <li>The rear and/or center levels are turned down.</li> <li>The surround and/or center speakers are disconnected.</li> </ul>	<ul style="list-style-type: none"> <li>See "SPEAKER SETTING" on p. 33–34 to check the speaker settings.</li> <li>See "CHANNEL LEVEL" p. 36 – 37 to check the speaker levels.</li> <li>Connect the speakers (see p. 4, 18).</li> </ul>



Symptom	Cause	Remedy
Sound is produced from some components, but not from digital components.	<ul style="list-style-type: none"> <li>• SIGNAL SELECT is set incorrectly.</li> <li>• The digital inputs are assigned incorrectly, or not at all.</li> </ul>	<ul style="list-style-type: none"> <li>• Set SIGNAL SELECT to "AUTO" or according to the type of connections made (see p. 47).</li> <li>• Set the digital input settings correctly (see p. 30).</li> </ul>
No sound is output or a noise is output when software with DTS is played back.	<ul style="list-style-type: none"> <li>• SIGNAL SELECT is set to "ANALOG".</li> <li>• A DVD player not compatible with DTS is used, or the setting of the DVD player is incorrect.</li> <li>• The digital output level has been turned down on a CD player or other component equipped with digital output level adjustment capability. (The DTS signal has been altered by the player, and cannot be read.)</li> <li>• The speakers are turned OFF.</li> </ul>	<ul style="list-style-type: none"> <li>• Make digital connections (see p. 12 &amp; 13) and set SIGNAL SELECT to "AUTO" (see p. 47).</li> <li>• Refer to the instruction manual supplied with the DVD player.</li> <li>• Set the digital volume level of the player to full, or to the neutral position.</li> <li>• Turn the speakers ON.</li> </ul>
The sound is output intermittently when software with DTS is played back.	<ul style="list-style-type: none"> <li>• Disc being played back has a huge amount of information on it.</li> </ul>	<ul style="list-style-type: none"> <li>• Use the STANDARD mode to get the best results (see p. 41 &amp; 44).</li> </ul>
When a search is performed by a DTS compatible CD player during playback, noise is output.	<ul style="list-style-type: none"> <li>• The search function performed by the player interferes with the reading of digital information.</li> </ul>	<ul style="list-style-type: none"> <li>• This is not a malfunction, but be sure to turn the volume down to prevent the output of loud noise from your speakers.</li> </ul>
Cannot be remote controlled.	<ul style="list-style-type: none"> <li>• The remote control batteries have worn out.</li> <li>• Too far away or bad angle of operation.</li> <li>• There is an obstacle between the receiver and the remote control.</li> <li>• Strong light such as fluorescent light is shining onto the unit's remote control signal light-receiving window.</li> <li>• A cord is connected to the CONTROL IN terminal on this unit.</li> </ul>	<ul style="list-style-type: none"> <li>• Replace the batteries (see p. 9).</li> <li>• Operate within 7 m, 30° of the remote sensor on the front panel (see p.10).</li> <li>• Remove the obstacle or operate from another position.</li> <li>• Avoid exposing the remote sensor on the front panel to direct light.</li> <li>• Connect cord to the correct jack.</li> </ul>
The display is dark.	<ul style="list-style-type: none"> <li>• The FL DIMMER button is pushed.</li> </ul>	<ul style="list-style-type: none"> <li>• Press FL DIMMER on the front panel repeatedly to return to the default setting (see p. 52).</li> </ul>
The OVER indicator is constantly lit.	<ul style="list-style-type: none"> <li>• If you are using an analog source, the signal is too strong</li> </ul>	<ul style="list-style-type: none"> <li>• Press the INPUT ATT button (see p. 24, #8).</li> </ul>
When playing a DTS format LD there is noise audible on the soundtrack.	<ul style="list-style-type: none"> <li>• If you are using a digital source, there is too much information for the receiver to handle.</li> <li>• The SIGNAL SELECT is on ANALOG.</li> </ul>	<ul style="list-style-type: none"> <li>• For <b>DD</b>/DTS sources put the receiver in STANDARD mode (see p. 44).</li> <li>• Set the SIGNAL SELECT to DIGITAL.</li> </ul>
You can't get DIGITAL to come up when using the SIGNAL SELECT button.	<ul style="list-style-type: none"> <li>• Either the digital connections or the DIGITAL INPUT ASSIGNMENTS are incorrect.</li> <li>• The MONITOR mode is ON.</li> </ul>	<ul style="list-style-type: none"> <li>• Make sure the digital connections and the DIGITAL INPUT ASSIGNMENTS are done correctly.</li> <li>• Press the MONITOR button so it goes into the OFF setting</li> </ul>
When using THX AUTO mode the receiver is not playing in the EX or ES mode.	<ul style="list-style-type: none"> <li>• You are not using an EX or ES source.</li> </ul>	<ul style="list-style-type: none"> <li>• There is no problem with your receiver but if you want to hear 7 channel sound switch to Surround EX mode.</li> </ul>
The DTS indicator doesn't light up even when playing a DTS source.	<ul style="list-style-type: none"> <li>• The player is paused or stopped.</li> <li>• There is a mistake in the player settings for audio output.</li> <li>• Although it's a DTS source there is a possibility the present track is not DTS.</li> </ul>	<ul style="list-style-type: none"> <li>• Play the source.</li> <li>• Fix the audio settings (check the manual that came with your DVD player).</li> <li>• There is no problem. The indicator won't light when the track is not a DTS track.</li> </ul>

**If the unit does not operate normally due to external effects such as static electricity**

Disconnect the power plug from the outlet and insert again to return to normal operating conditions.

# Specifications

## Amplifier Section

Maximum Output Power .....	130 W/channel
	(1 kHz, THD 10.0 %, 8Ω)
Continuous Power Output (STEREO MODE)	
FRONT .....	100 W + 100 W (DIN 1 kHz, THD 1 %, 8Ω)
Continuous Power Output (SURROUND MODE)	
FRONT .....	100 W + 100 W (DIN 1 kHz, THD 1 %, 8Ω)
CENTER .....	100 W (DIN 1 kHz, THD 1 %, 8Ω)
SURROUND .....	100 W + 100 W
	(DIN 1 kHz, THD 1 %, 8Ω)
Rated Power Output .....	100 W + 100 W
	(20 Hz – 20 kHz, THD 0.09 %, 8Ω)

- Above specifications are applicable when the power supply is 230V(for the Singaporean model).

Input (Sensitivity/Impedance)	
PHONO MM .....	4.7 mV/47 kΩ
VCR 1/DVR, VCR 2, DVD/LD, TV/SAT, VIDEO, CD,	
CD-R/TAPE 1/MD, TAPE 2 .....	335 mV/47 kΩ
Phono Overload level (THD 0.1 %, 1kHz)	
PHONO MM .....	120 mV
Frequency Response	
PHONO MM .....	20 Hz to 20,000 Hz ± 0.3 dB
VCR 1/DVR, VCR 2, DVD/LD, TV/SAT, VIDEO, CD,	
CD-R/TAPE 1/MD, TAPE 2 .....	5 Hz to 100,000 Hz ± 0.3 dB
Output (Level/Impedance)	
VCR 1/DVR REC, VCR 2 REC, CD-R/TAPE 1/MD REC,	
TAPE 2 REC .....	335 mV/2.2 kΩ
Tone Control	
BASS .....	± 6 dB (100 Hz)
TREBLE .....	± 6 dB (10 kHz)
LOUDNESS .....	+10 dB (100 Hz/10 kHz)
Signal-to-Noise Ratio (IHF, short circuited, A network)	
PHONO MM .....	80 dB
VCR 1/DVR, VCR 2, DVD/LD, TV/SAT, VIDEO, CD,	
CD-R/TAPE 1/MD, TAPE 2, MULTI CH IN .....	97 dB

### Singaporean model

Signal-to-Noise Ratio [DIN (Continuous rated power output/50 mW)]	
PHONO MM .....	68/61 dB
VCR 1, VCR 2, DVD/LD, TV/SAT, VIDEO, CD, MD/TAPE 1,	
TAPE 2 .....	92/65 dB

### Other model

Signal-to-Noise Ratio [EIA, at 1 W (1 kHz)]	
PHONO MM .....	80 dB
VCR 1, VCR 2, DVD/LD, TV/SAT, VIDEO, CD, MD/TAPE 1,	
TAPE 2 .....	83 dB

## VIDEO Section (S jack)

Input (Sensitivity/Impedance)	
VCR 1/DVR, VCR 2, VIDEO, DVD/LD, TV/SAT	
Luminance signal (Y) .....	1 Vp-p/75 Ω
Chrominance signal (C) .....	0.286 Vp-p/75 Ω
Output (Level/Impedance)	
VCR 1/DVR, VCR 2, MONITOR OUT	
Luminance signal (Y) .....	1 Vp-p/75 Ω
Chrominance signal (C) .....	0.286 Vp-p/75 Ω
Frequency Response	
VCR 1/DVR, VCR 2, VIDEO, DVD/LD, TV/SAT	
Luminance signal (Y) .....	5 Hz to 10 MHz ± 0.3 dB
Signal-to-Noise Ratio	
Luminance signal (Y) .....	65 dB

## Component Video Section

Input (Sensitivity)	
Y .....	1 Vp-p/75 Ω
PB/PR .....	0.7 V/75 Ω
Output (Level/Impedance)	
Y .....	1 Vp-p/75 Ω
PB/PR .....	0.7 V/75 Ω
Frequency Response	
Y .....	5 Hz to 20 MHz ± 0.3 dB
PB/PR .....	5 Hz to 13 MHz ± 0.3 dB

## VIDEO Section (Composite)

Input (Sensitivity/Impedance)	
VCR 1/DVR, VCR 2, VIDEO, DVD/LD,	
TV/SAT .....	1 Vp-p/75 Ω
Output (Level/Impedance)	
VCR 1/DVR, VCR 2, MONITOR OUT,	
MONITOR OUT2 .....	1 Vp-p/75 Ω
Frequency Response	
VCR 1/DVR, VCR 2, TV/SAT, DVD/LD	
VIDEO→MONITOR OUT, .....	5 Hz to 10 MHz ± 0.3 dB
Signal-to-Noise Ratio .....	65 dB

## FM Tuner Section

Frequency Range .....	87.5 MHz to 108 MHz
Usable Sensitivity	
Singaporean model .....	Mono: 15.2 dBf, IHF (1.6 μV/75 Ω)
Other model .....	Mono: 13.2 dBf, IHF (1.3 μV/75 Ω)
50 dB Quieting Sensitivity	
Singaporean model .....	Mono: 20.2 dBf
	Stereo: 41.2 dBf
Other model .....	Mono: 20.2 dBf
	Stereo: 38.6 dBf
Signal-to-Noise Ratio	
Singaporean model .....	Mono: 76 dB (at 85 dBf)
	Stereo: 72 dB (at 85 dBf)
Other model .....	Mono: 73 dB (at 85 dBf)
	Stereo: 70 dB (at 85 dBf)
Distortion	
Singaporean model .....	Stereo: 0.6 % (1 kHz)
Other model .....	Stereo: 0.5 % (1 kHz)
Alternate Channel Selectivity	
Singaporean model .....	70 dB (400 kHz)
Other model .....	60 dB (400 kHz)
Stereo Separation .....	40 dB (1 kHz)
Frequency Response .....	30 Hz to 15 kHz ± 1dB
Antenna Input .....	75 Ω unbalanced

## AM Tuner Section

Frequency Range	
Singaporean model .....	531 kHz to 1,602 kHz(9 kHz step)
Other model .....	531 kHz to 1,602 kHz(9 kHz step)
	530 kHz to 1,700 kHz(10 kHz step)
Sensitivity (IHF, Loop antenna) .....	350 μV/m
Selectivity	
Singaporean model .....	30 dB
Other model .....	20 dB
Signal-to-Noise Ratio .....	50 dB
Antenna .....	Loop antenna

**Miscellaneous**

Power Requirements  
 Singapore model ..... AC 220 - 230 V, 50/60 Hz  
 Other model ..... AC 110/120-127/220/240 V, 50/60 Hz

Power Consumption  
 Singapore model ..... 400 W  
 Other model ..... 1,000 W

Power Consumption in Standby mode ..... 1.0 W

AC Outlets  
 SWITCHED (x2) ..... Total 100 W MAX.

Dimensions ..... 420 (W) × 173 (H) × 463 (D) mm

Weight (without package) ..... 17.6 kg

**Furnished Parts**

FM wire Antenna ..... 1  
 AM loop Antenna ..... 1  
 "AA" IEC LR6 batteries ..... 2  
 Remote control unit ..... 1  
 Operating Instructions ..... 1

**NOTE:**

*Specifications and the design are subject to possible modifications without notice, due to improvements.*

**Power cord CAUTION**

Handle the power cord by the plug. Do not pull out the plug by tugging the cord and never touch the power cord when your hands are wet as this could cause a short circuit or electric shock. Do not place the unit, a piece of furniture, etc., on the power cord, or pinch the cord. Never make a knot in the cord or tie it with other cords. The power cords should be routed such that they are not likely to be stepped on. A damaged power cord can cause a fire or give you an electrical shock. Check the power cord once in a while. When you find it damaged, ask your nearest PIONEER authorized service center or your dealer for a replacement.

**Maintenance of External Surfaces**

- Use a polishing cloth or dry cloth to wipe off dust and dirt.
- When the surfaces are dirty, wipe with a soft cloth dipped in some neutral cleanser diluted five or six times with water, and wrung out well, and then wipe again with a dry cloth. Do not use furniture wax or cleansers.
- Never use thinners, benzine, insecticide sprays or other chemicals on or near this unit, since these will corrode the surfaces.

Published by Pioneer Corporation.  
Copyright © 2000 Pioneer Corporation.  
All rights reserved.

---

**PIONEER CORPORATION** 4-1, Meguro 1-Chome, Meguro-ku, Tokyo 153-8654, Japan  
**PIONEER ELECTRONICS [USA] INC.** P.O. BOX 1540, Long Beach, California 90801-1540, U.S.A.  
**PIONEER ELECTRONICS OF CANADA, INC.** 300 Allstate Parkway, Markham, Ontario L3R 0P2, Canada  
**PIONEER EUROPE NV** Haven 1087, Keetberglaan 1, B-9120 Melsele, Belgium TEL: 03/570.05.11  
**PIONEER ELECTRONICS AUSTRALIA PTY. LTD.** 178-184 Boundary Road, Braeside, Victoria 3195, Australia, TEL: [03] 9586-6300  
**PIONEER ELECTRONICS DE MEXICO S.A. DE C.V.** San Lorenzo 1009 3er Piso Desp. 302 Col. Del Valle Mexico D.F. C.P. 03100  
TEL: 5-688-52-90

<TKWZF/00H00001>

Printed in Belgium <ARB7226-A>